

# innovations

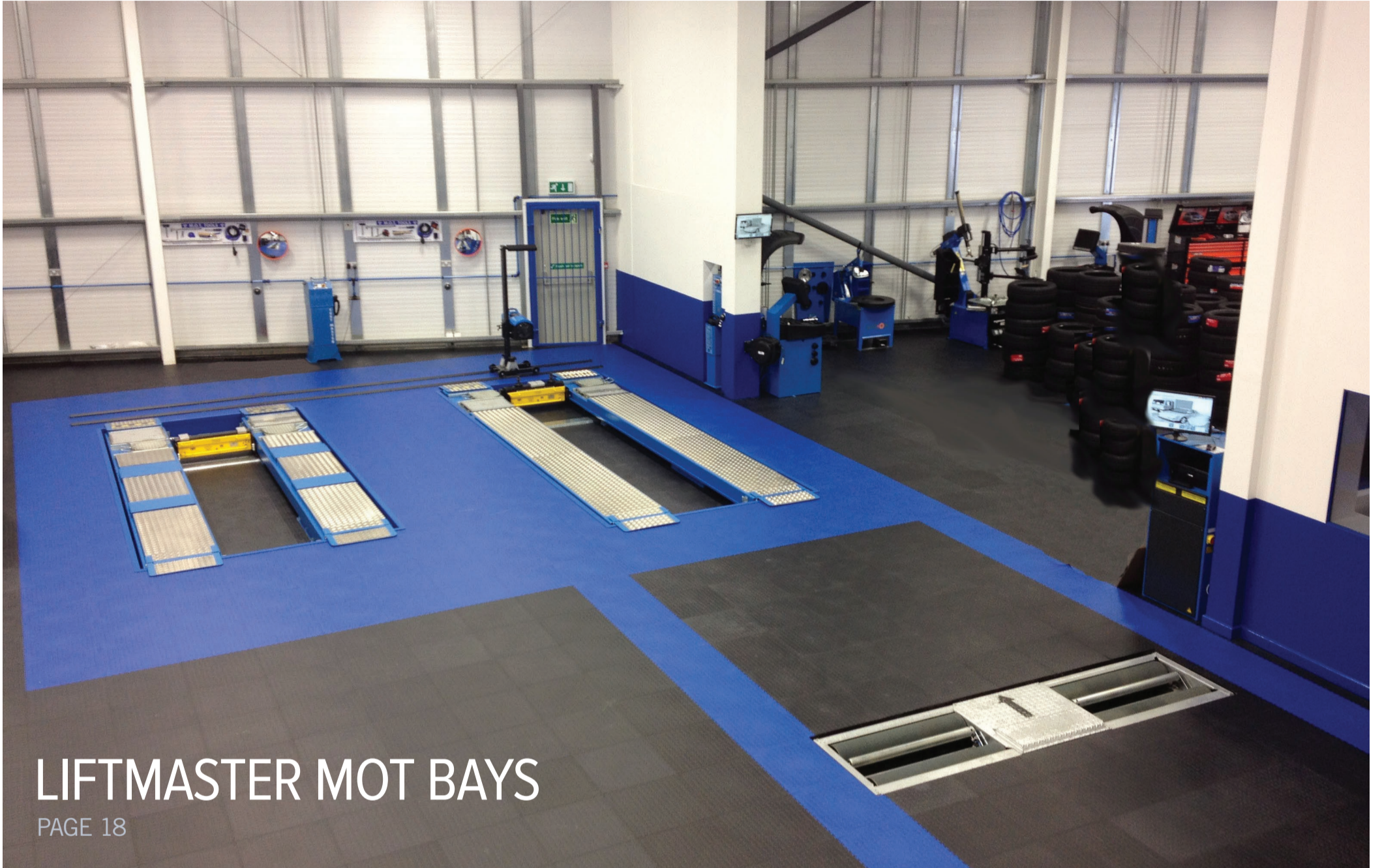

## LIFTMASTER MOT BAYS

PAGE 18

## PREMIER DIAGNOSTICS

PAGE 22

ALSO IN THIS ISSUE:

- Training PAGE 03
- MVP Pro PAGE 07
- John Bean Alignment PAGE 08
- Bosch Wheel Alignment PAGE 15
- Launch X431 Euro Pad PAGE 36
- Pico PAGE 38
- G-Scan PAGE 39



## THERMOBILE HEATERS

PAGE 4



0845 603 3636  
OVER 180 BRANCHES NATIONWIDE

Offers valid until 30 April 2015



# Buy or Lease with Confidence

All of us at Euro Car Parts aim to provide you with the tools, equipment and service that match both your personal expectations and your business requirements.

We're also with you for the long haul, understanding that delivering true value comes from developing good long-term relationships.

Put simply, if we can ensure that every pound you spend on garage equipment has the potential to bring you the maximum returns then you might think of us next time you're in the market for equipment.

That's why we only use suppliers who can offer a comprehensive warranty service and update backup for the life of the equipment.

We will also arrange demonstrations wherever possible and offer advice on the best products and services to suit your business.

## OUR PROMISE:

- We make sure the equipment you buy is right for you.
- We only put products in front of you that we know are fully supported in the UK by the manufacturer.
- We provide you with the best possible service now and in the future.

**NO HASSLE  
WARRANTY**

**BEST PRICE  
PROMISE**

## THE ADVANTAGES OF LEASING

### 1. PAYMENTS ARE TAX DEDUCTIBLE

Lease payments are classed as a rental or business expense and therefore can be offset against profits made over the financial year.

### 2. ABILITY TO HAVE THE BEST PRODUCT AVAILABLE

Choosing the cheaper option can prove to be a false economy as that equipment often needs replacing sooner than the best quality product available to you.

### 3. PAY AS YOU EARN

Most equipment either saves you money or makes you money, therefore the equipment pays for the lease as it works for you.

### 4. PAYMENTS ARE FIXED

Fixed payments make it easier for you to budget and plan your major purchases.

### 5. IMPROVES CASH FLOW AND PROTECTS OTHER CREDIT LINES

By leasing equipment you can protect your cash and other lines of credit.

All figures subject to status and acceptance, and do not form an offer of finance. All prices plus VAT at the current rate. Euro Car Parts reserves the right to change or amend pricing and offers at any time. Prices correct at time of going to press (January 2015). Images and descriptions are indicative of products. The equipment prices/offers are applicable for UK mainland only. All lease prices quoted are subject to business trading over 3 years and subject to credit clearance; all weekly prices calculate on a five-year lease. Errors and omissions excluded. All purchases and offers contained in this publication are subject to Euro Car Parts terms and conditions which can be found at [www.eurocarparts.com/terms-and-conditions](http://www.eurocarparts.com/terms-and-conditions)

OVER 180 BRANCHES NATIONWIDE 0845 603 3636

# Bosch Training

## REDUCE THE COST OF YOUR TRAINING WITH EURO CAR PARTS

At Euro Car Parts we pride ourselves on exceeding customer expectations. We have a well-deserved reputation for outstanding availability, service and value. We now extend that value to Technician Training.

With the ever-increasing complexity and sophistication of vehicles and a shortage of skilled individuals, there has never been a greater need for garages to train their technicians. Euro Car Parts can now give you access to the full range of Bosch Diagnostic Technician and Master Technician Courses held at their multi-million pound Service Training Centre in Uxbridge. Course dates are available throughout the year.

Completion of the training programme shown below will ensure your technicians have the necessary skills to sit an ATA Accreditation.

More information about the ATA Light Vehicle Maintenance and Repair route can be found here:

<http://ata.theimi.org.uk/light-vehicle-maintenance-repair-route>

If you wish to discuss your staff training requirements or receive the Bosch training prospectus please call your local branch or email: [training@eurocarparts.com](mailto:training@eurocarparts.com)

## BOSCH DIAGNOSTIC TECHNICIAN PROGRAMME 2015

25 days of training  
+  
1 day ATA assessment

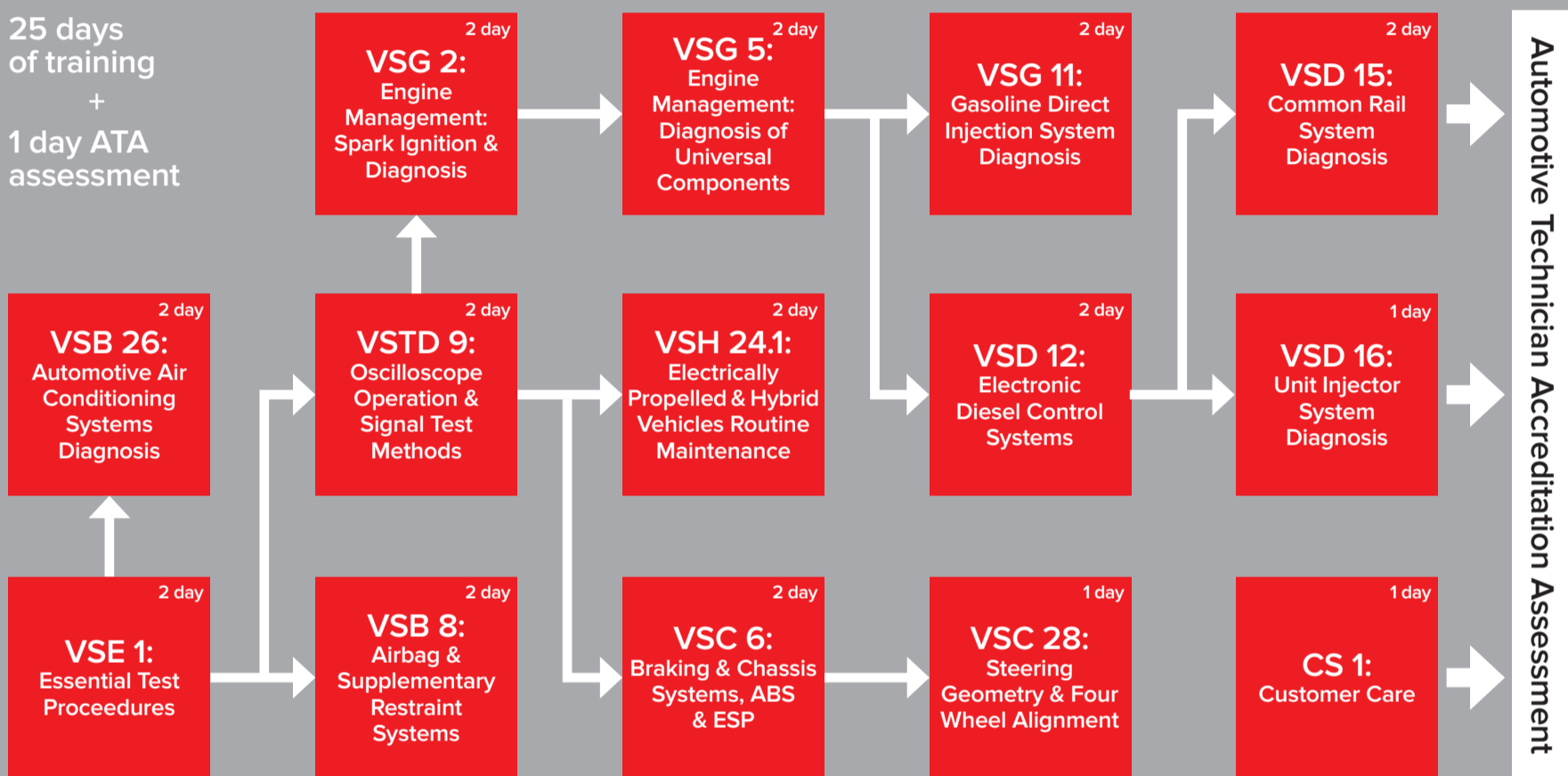

## BOSCH MASTER TECHNICIAN PROGRAMME 2015

21 days of training  
+  
1 day ATA assessment

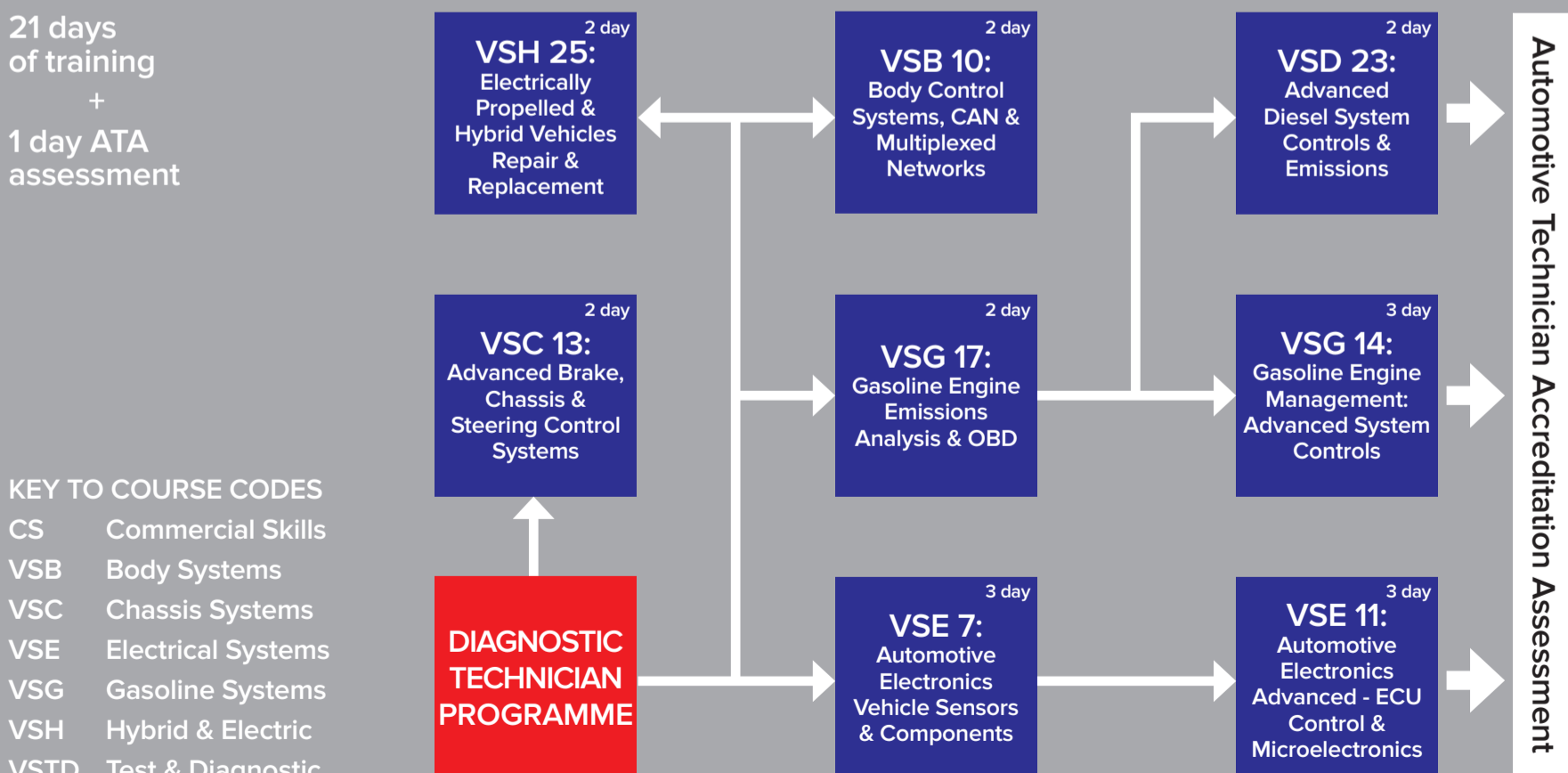

KEY TO COURSE CODES  
CS Commercial Skills  
VSB Body Systems  
VSC Chassis Systems  
VSE Electrical Systems  
VSG Gasoline Systems  
VSH Hybrid & Electric  
VSTD Test & Diagnostic



KNOWLEDGE AND EXPERTISE ACROSS THE UK 0845 603 3636

# Workshop Heaters

## THERMOBILE MANUAL IGNITION WASTE OIL HEATERS



Detail image of ignition draw -easy, convenient, safe operation, models AT400 & AT500.

Heaters shown require flue kit (not shown) to operate.

- Proven reliability for years of efficient heating
- Vapour-free combustion with unique ducted air and sealed vents design
- Pound for pound the best value heaters available
- AT Heater Range - The best manual-lit range available

**FREE SPARES KIT WORTH £100 FOR FIRST 100 CUSTOMERS THAT PURCHASE THE AT307\***

Kit includes combustion dish, thermostat, inlet tube and top seal



### AT306

Radiant heat, open flame combustion recommended only for workshops where no explosive vapours are present.

### AT306 THERMO

Radiant heat, open flame combustion combined with a 'THERMO' blower, recommended only for workshops where no explosive vapours are present.

### AT307 TOP SELLER

Enclosed flame combustion combined with a 'THERMO' blower. A unique feature is that air can be ducted from outside for a vapour-free clean air supply.

### AT400 TOP SELLER

Enclosed flame combustion combined with a high capacity axial fan. Combustion air can be ducted from outside for a vapour-free clean air supply. Ignition drawer system as standard for easy lighting and maintenance.

### AT500 TOP SELLER

Very high-efficiency heater with built-in, large-surface heat exchanger. Enclosed flame combustion combined with a high capacity axial fan. Combustion air can be ducted from outside for a vapour-free clean air supply. Ignition drawer system as standard for easy lighting and maintenance.

MODEL	DESCRIPTION	PRICE	WEEKLY FROM*
AT306 Kit	Waste Oil Heater + Complete Flue Kit, 68,000 - 102,000 BTU/h	£1,095.00	£6.03
AT306 Thermo Kit	Fan Assisted Waste Oil Heater + Complete Flue Kit, 68,000 - 102,000 BTU/h	£1,195.00	£6.58
AT307 Kit	Fan Assisted Waste Oil Heater with Enclosed Combustion + Complete Flue Kit, 68,000 - 102,000 BTU/h (+*FOC Spares Kit worth £100 whilst stocks last)	£1,495.00	£8.24
AT400 Kit	Fan Assisted Waste Oil Heater with Enclosed Combustion and Built-in Large Surface Heat Exchanger + Complete Flue Kit, 85,000 - 143,000 BTU/h	£2,250.00	£12.39
AT500 Kit	Fan Assisted Waste Oil Heater with Enclosed Combustion and Built-in Large Surface Heat Exchanger + Complete Flue Kit, 123,000 - 210,000 BTU/h	£2,595.00	£14.29

## INFORMATION REGARDING SMALL WASTE OIL BURNERS (SWOBS)

To make you aware that the Department for Environment Food and Rural Affairs (Defra) is conducting a review of guidance on the implementation of the European Union Waste Incineration Directive and it's application to small waste oil burners in England and Wales.

This is on-going, and no timescale has been set. In order to burn waste oil, you will need to register with your local authority. There is an initial charge to do this, followed by a chargeable annual update licence.

## NEW PRODUCT HEATER BOOSTERS

Get up to 91% efficiency from your heater by fitting a booster.

Easy to fit - slots neatly to the flue system. Order with your new heater or retro-fit to your existing heater.

To fit 150mm diameter flue  
**ONLY £289.99**



All prices are for delivery only and exclude VAT. Output depends on type of waste oil.\*Based on a five-year lease agreement. Subject to status. Full terms and conditions available on request. Other lease terms and finance options available on request. Offers valid until 30 April 2015. Prices correct at time of going to press: January 2015. Prices exclude VAT, VAT will be applied at current rate. Errors & omissions excluded.

OVER 180 BRANCHES NATIONWIDE 0845 603 3636

**NO HASSLE  
WARRANTY**

**BEST PRICE  
PROMISE**

# THERMOBILE AUTOMATIC IGNITION WASTE OIL HEATERS

- Multifuel capability, can also operate on heating oil or diesel
- Minimal maintenance heaters
- Clean, soot-free combustion
- 1 Phase/3 Phase motors
- Rotatable Vents
- Insulated panels
- Summer ventilation facility



Heaters shown require flue kit (not shown) to operate.

**HEATER + FLUE KIT + PUMP  
PACKAGE OFFER**

## UPTO 204,000 BTU **1 PHASE MOTORS** ROTATABLE VENTS FOR PRECISE CONTROL

MODEL	DESCRIPTION	PRICE	WEEKLY FROM*
SB40 Kit	Automatic Ignition Waste Oil Heater with Complete Flue Kit and Standard Pump Max 153,000 BTU/h	<b>£3,895.00</b>	<b>£21.46</b>
SB60 Kit	Automatic Ignition Waste Oil Heater with Complete Flue Kit and Standard Pump Max 204,000 BTU/h	<b>£4,250.00</b>	<b>£23.41</b>

## GREATER THAN 204,000 BTU **3 PHASE MOTORS** ROTATABLE VENTS FOR PRECISE CONTROL

MODEL	DESCRIPTION	PRICE	WEEKLY FROM*
SB80 Kit	Automatic Ignition Waste Oil Heater with Complete Flue Kit and Standard Pump Max 306,000 BTU/h	<b>£5,995.00</b>	<b>£31.54</b>
SB110 Kit	Automatic Ignition Waste Oil Heater with Complete Flue Kit and Standard Pump Max 436,000 BTU/h	<b>£6,795.00</b>	<b>£35.75</b>

All prices are for delivery only and exclude VAT. Output depends on type of waste oil.\*Based on a five-year lease agreement. Subject to status. Full terms and conditions available on request. Other lease terms and finance options available on request. Offers valid until 30 April 2015. Prices correct at time of going to press: January 2015. Prices exclude VAT, VAT will be applied at current rate. Errors & omissions excluded.

KNOWLEDGE AND EXPERTISE ACROSS THE UK **0845 603 3636**

# Workshop Heaters

NO HASSLE  
WARRANTY

BEST PRICE  
PROMISE

## THERMOBILE OIL FIRED CABINET HEATERS

Factory set for either for either Diesel 35 second or Kerosene 28 second fuel oil, your choice!

- 91% efficiency models
- Inbuilt Thermostat Timer
- Combustion Air intake kit included as standard
- Output range across the models from 380kW to 501kW
- 12 months parts & labour warranty plus a further 12 months parts only warranty

### HEATER + FLUE KIT PACKAGE OFFER

All BSO heater kits come with complete 4.5 metre from ground flue kit.

All prices - delivered to UK mainland.



**ALSO AVAILABLE**  
WALL OR CEILING  
SUSPENDED  
THERMOBILE  
OIL OR GAS  
HEATER SYSTEMS



Information available on request - please call

MODEL	DESCRIPTION	PRICE	WEEKLY FROM*
BSO 30 Kit	BSO 30 Oil-Fired Cabinet Heater with Complete Flue Kit, heat output 109,000 BTU/h	£2,375.00	£13.08
BSO 40 Kit	BSO 40 Oil-Fired Cabinet Heater with Complete Flue Kit, heat output 146,000 BTU/h	£2,475.00	£13.63
BSO 60 Kit	BSO 60 Oil-Fired Cabinet Heater with Complete Flue Kit, heat output 203,000 BTU/h	£2,795.00	£15.40
BSO 85 Kit	BSO 85 Oil-Fired Cabinet Heater with Complete Flue Kit, heat output 280,000 BTU/h	£2,995.00	16.49
BSO 120 Kit	BSO 120 Oil-Fired Cabinet Heater with Complete Flue Kit, heat output 418,000 BTU/h	£3,575.00	£19.68

# Thermobile Heater Spares

NO HASSLE  
WARRANTY

BEST PRICE  
PROMISE

COMBUSTION DISH  
FOR AT 400/500  
594 77 1020



ONLY £82.00

COMBUSTION DISH  
FOR AT 306/307  
594 77 1080

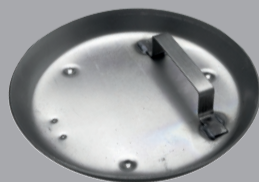

ONLY £33.50

KLIXON FOR  
AT 306/307/400/500  
594 77 1090



ONLY £17.50

LIMIT THERMOSTAT FOR  
AT 306/307/400/500  
594 77 0190

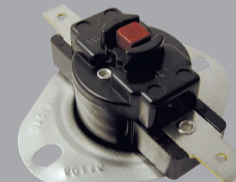

ONLY £16.00

INLET TUBE FOR  
AT 306/307  
594 77 1070

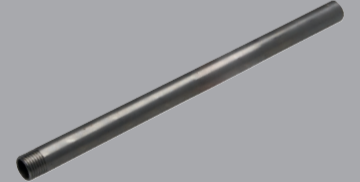

ONLY £6.95

INLET TUBE FOR  
AT 400/500  
594 77 1040



ONLY £6.95

BURNER RING FOR  
AT 306/307/400/500  
594 77 1010

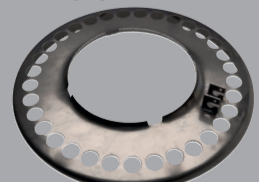

ONLY £45.00

TOP SEALING CORD FOR  
AT 306/307/400/500  
594 77 0210



ONLY £6.80

BOTTOM SEALING CORD  
FOR AT 400/500  
594 77 1030



ONLY £15.25

DRAUGHT FLAP FOR  
AT 306/307/400/500  
594 77 0160



ONLY £32.50

All prices are for delivery only and exclude VAT. \*Based on a five-year lease agreement. Subject to status. Full terms and conditions available on request. Other lease terms and finance options available on request. Offers valid until 30 April 2015. Prices correct at time of going to press: January 2015. Prices exclude VAT, VAT will be applied at current rate. Errors & omissions excluded.

OVER 180 BRANCHES NATIONWIDE 0845 603 3636

# Key Programming

NO HASSLE  
WARRANTY

BEST PRICE  
PROMISE

## NEW PRODUCT

### MVP PRO KEY PROGRAMMING SYSTEM

It's not as complicated or expensive as you think - and it's extremely profitable!

The MVP Pro is the latest key programming tool to be launched from UK - based world leaders Advanced Diagnostics.

Key and remote programming is still a niche and profitable service; therefore is a cost effective way to increase your business. Adding this extension to your business enables you to offer a service which will not be available from many of your competitors.

**Never pay for software, all updates now and in the future are free of charge.**

The MVP Pro works on a 'Pay as you Go' basis using electronic tokens (1 token per vehicle) which can be purchased easily and quickly on the internet. One token is £27.50 + VAT, 20 tokens bought together are £21.25 + VAT per vehicle. When you are running at more than 20 tokens per month, you can change to buying monthly unlimited tokens at £195.00 + VAT.

**With this great offer, the MVP Pro is completely free to use for the first 6 months.**



### MVP KEY PROGRAMMING BASE UNIT ONLY **£1,995.00**

*"Anyone who wants to offer Key Programming now has a step in the door ... at a price any garage can afford"*

- All makes coverage
- Reads immobiliser ECU ID's
- Reads mechanical key codes
- Clears key memories
- Programs new keys
- Programs remote controls
- ECU identification
- Reads fault codes
- Displays live data
- Component actuation
- Internet software updates
- Electronic tokens downloaded from the web
- Technical hotline
- Technical support forum
- USB PC interface
- Standard and test software
- adjustable contrast
- Multiple languages supported
- Pin code services online
- Smartcheck security calculator



## OFFER

MVP PRO KEY PROGRAMMING SYSTEM (WORTH **£1,995.00 + VAT**)

6 MONTHS FREE UNLIMITED TOKEN PLAN (WORTH **£1,175.00 + VAT**)

1 DAYS FREE USER TRAINING COURSE FOR 1 PERSON (WORTH **£200 + VAT**)

12 MONTHS TECH SUPPORT AND WARRANTY

PACKAGE WORTH **£3,365.00 + VAT**

**NOW ONLY £2,795.00 + VAT - WHILE STOCKS LAST!**

MODEL	DESCRIPTION	PRICE	WEEKLY FROM*
MVP Pro Key Programming Package	Base Unit, 6 Months Tokens, 1 Day Training, 12 Months Support	<b>£2,795.00</b>	<b>£15.40</b>

\*Based on a five-year lease agreement. Subject to status. Full terms and conditions available on request. Other lease terms and finance options available on request. Offers valid until 30 April 2015. Prices correct at time of going to press: January 2015. Prices exclude VAT, VAT will be applied at current rate. Errors & omissions excluded.

KNOWLEDGE AND EXPERTISE ACROSS THE UK **0845 603 3636**

# John Bean Wheel Alignment Systems

## NEW - JOHN BEAN V3400 WIRELESS IMAGING ALIGNMENT SYSTEM

- Now, with just one aligner, all the platform lifts on the site could be bringing in 3D alignment income!
- Wireless communication – the PC cabinet stays in one place, but the camera towers can be moved from platform lift to platform lift, through wireless communication with the PC.
- Speed and Productivity – no loss of speed carrying out an alignment, as the cameras automatically track the lift height. Get readings in less than two minutes on a wide variety of vehicles and wheel sizes.
- Includes the new John Bean AC400 contact less wheel clamps



ONLY **£14,999.00**  
WEEKLY FROM ONLY **£78.92<sup>+</sup>**

## CABLE-FREE LASER ALIGNMENT SYSTEM

- Suitable for pit, lift or floor use
- Rechargeable batteries for cable-free operation
- Simple hang-on mounting system
- Supplied with turning discs and bases, and steering wheel holder
- Alignment data wall chart
- Suitable for 12" to 24" wheels – extension also available
- Installation not included – supplied with training DVD
- 2-year manufacturer warranty

### OPTIONAL EXTRAS

Camber, castor and kingpin inclination gauge upgrades the above aligner model to measure camber, castor and kingpin inclination.



A300 (WALL MOUNTED)  
ONLY **£1,899.00**  
WEEKLY FROM ONLY  
**£10.46<sup>+</sup>**



A350 (TROLLEY MOUNTED)  
ONLY **£2,150.00**  
WEEKLY FROM ONLY  
**£11.84<sup>+</sup>**

### ROLL BACK KIT

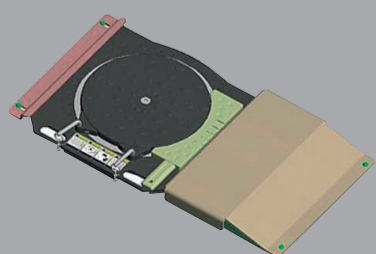

ONLY **£349.00**

### TURN PLATES

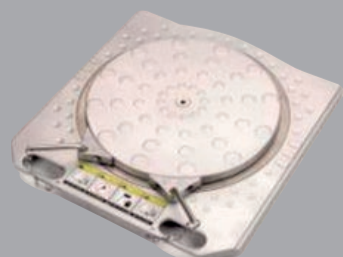

ONLY **£525.00**

### STEERING WHEEL LEVEL

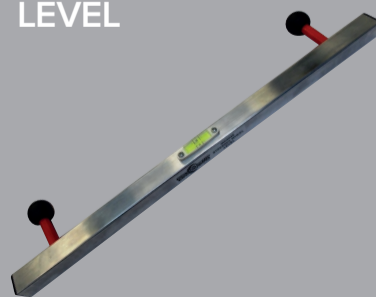

ONLY **£99.00**

### REAR SLIP PLATES (1 METRE)

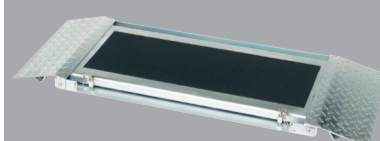

ONLY **£1,275.00**  
WEEKLY FROM **£6.66<sup>+</sup>**

### PORTABLE REAR TURN/SLIP PLATES



ONLY **£295.00**

\*Based on a five-year lease agreement. Subject to status. Full terms and conditions available on request. Other lease terms and finance options available on request. Offers valid until 30 April 2015. Prices correct at time of going to press: January 2015. Prices exclude VAT, VAT will be applied at current rate. Errors & omissions excluded.

OVER 180 BRANCHES NATIONWIDE **0845 603 3636**



**NO HASSLE  
WARRANTY**

**BEST PRICE  
PROMISE**

## VISUALINER 3D LITE + LIFT PACKAGE

3D wheel alignment is one of the fastest growing businesses in the UK, so if you're thinking of getting started then John Bean has the product for you. The John Bean alignment range is probably the broadest in the UK.

### VISUALINER 3D LITE

The Visualiner Lite is a 3D computerised alignment machine. Owing to its efficient camera technology, simple use and space-saving design this aligner is of interest for small shops too.

- Movable camera beam support (lift-flexible working height 0-2m) and control terminal fitted on lift
- Control terminal with shelves for PC and printer, and additional storage
- 19" TFT monitor
- PC with Windows operating system and standard user software
- Set of 4 universal wheel clamps – clamping range 11"-22"
- Simple operation and quick, accurate measured results
- Power supply 230V 50/60Hz
- 4 Targets
- Colour printer
- Loudspeakers
- Cordless communication between targets and camera system
- Complete and up-to-date OEM specs
- 3D overall display
- Standard accessories: brake pedal lock and steering wheel holder
- 2-year manufacturer warranty



**ONLY £8,099.00**

**WEEKLY FROM ONLY £42.61<sup>†</sup>**

#### EXAMPLE PACKAGE COMPRISES:

**VISUALINER PRISM PRO-42 LITE £7,999.00 + ALIGNMENT BAY 4-POST LIFT £6,350.00  
+ 2.0-TONNE JACKING BEAM £775.00 + FRONT ALIGNMENT TURN PLATES £525.00**

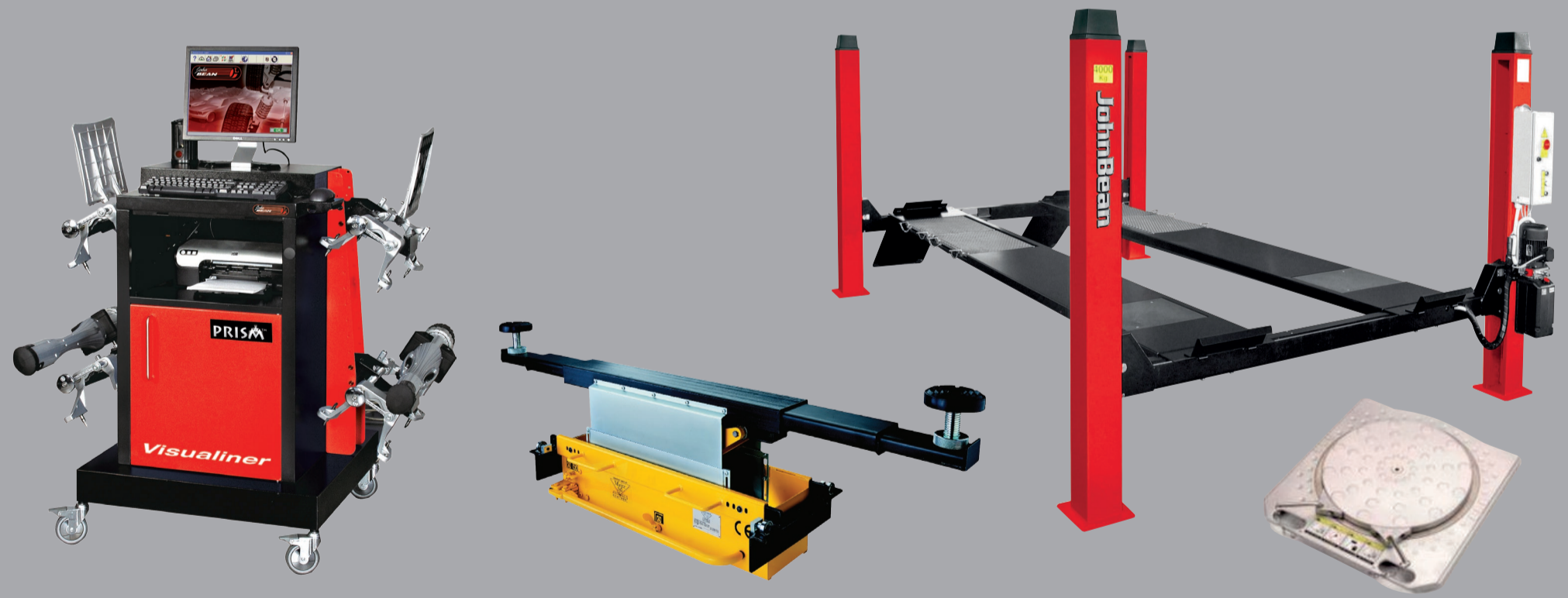

**COMPLETE PACKAGE from £15,545.00 a huge saving of £1,154.00  
WEEKLY FROM ONLY £85.00<sup>†</sup>**

LIFT PACKAGES	ALIGNMENT SYSTEM	4.8M 4 POST ALIGNMENT LIFT	TURNPLATES	SLIP PLATES	JACKING BEAM	PRICE	WEEKLY FROM <sup>†</sup>
Offer 1 - Prism	●	●	●	●	●	<b>£15,545.00</b>	<b>£85.00</b>
Offer 2 - V3D Lite	●	●	●	●	●	<b>£16,545.00</b>	<b>£111.79</b>
Offer 3 - V3400	●	●	●	●	●	<b>£23,395.00</b>	<b>£123.09</b>

<sup>†</sup>Based on a five-year lease agreement. Subject to status. Full terms and conditions available on request. Other lease terms and finance options available on request. Offers valid until 30 April 2015. Prices correct at time of going to press: January 2015. Prices exclude VAT, VAT will be applied at current rate. Errors & omissions excluded.

**KNOWLEDGE AND EXPERTISE ACROSS THE UK 0845 603 3636**

# John Bean Wheel Balancing

NO HASSLE  
WARRANTY

BEST PRICE  
PROMISE

B9400



ONLY **£1,499.00**  
WEEKLY FROM ONLY **£8.25<sup>+</sup>**

B9655



ONLY **£2,499.00**  
WEEKLY FROM ONLY **£13.77<sup>+</sup>**

**NEW PRODUCT**  
BFH 600



ONLY **£3,995.00**  
WEEKLY FROM ONLY **£22.00<sup>+</sup>**

John Bean wheel balancing solutions are reliable, accurate and operator-friendly with the fastest floor-to-floor times in the industry. All prices include delivery, installation, 2-year warranty and on-site training.

JOHN BEAN WHEEL BALANCER	B9400	B9655	BFH600
Display	LED	Video	LED - eye level
Motorised wheel balancer with hood and auto-start	-	●	●
Handspin – no hood – small foot print ideal for small garages	●	-	-
User profiles – these can be used for popular wheel/tyre combinations	1	4	4
Rim distance data input	Automatic	Automatic	Automatic
Rim diameter data input	Manual	Automatic	Automatic
Wheel width data input	Manual	Manual	Automatic
Gauge arm with patented wheel weight positioning system	●	●	●
Pedal-operated main shaft lock	●	●	●
Automatic braking after measurement	●	●	●
Hidden weight mode	●	●	●
ALU mode	●	●	●
PAX wheel mode	-	●	●
Rim width (inches)	2-20	1-20	1-20
Rim diameter (inches)	10-30	8-30	8-25
Maximum tyre width (mm)	500	508	508
Maximum wheel diameter (mm)	900	1050	1050
Power supply	200-240V	200-240V	200-240V
2-year on-site parts and labour warranty	●	●	●
On-site training (45 minutes)	●	●	●
Country of manufacture	Italy	Italy	Italy

\*Based on a five-year lease agreement. Subject to status. Full terms and conditions available on request. Other lease terms and finance options available on request. Offers valid until 30 April 2015. Prices correct at time of going to press: January 2015. Prices exclude VAT, VAT will be applied at current rate. Errors & omissions excluded.

OVER 180 BRANCHES NATIONWIDE 0845 603 3636

# John Bean Tyre Changers

NO HASSLE  
WARRANTY

BEST PRICE  
PROMISE

T1000

T3000  
+ MH320

T5000

CENTAUR PLATINUM



ONLY **£1,595.00**  
WEEKLY FROM  
ONLY **£8.78<sup>†</sup>**

ONLY **£3,195.00**  
WEEKLY FROM  
ONLY **£17.59<sup>†</sup>**

ONLY **£3,895.00**  
WEEKLY FROM  
ONLY **£21.45<sup>†</sup>**

ONLY **£8,995.00**  
WEEKLY FROM  
ONLY **£47.33<sup>†</sup>**

John Bean tyre changers are easy to use, provide broad coverage and boost productivity. All prices include delivery, installation, 2-year warranty and on-site training.

JOHN BEAN TYRE CHANGER	T1000	T3000 + MH320	T5000	CENTAUR PLATINUM
Swing arm	●	-	-	-
Tilt back post pneumatically controlled tilt back	-	●	-	-
Tilt back post pneumatically controlled tilt back and forward	-	-	●	●
Double-acting bead breaker	●	●	●	Twin
Self-centering four-jaw chuck	●	●	●	●
Roller board for easier bead breaking	Option	-	●	-
Helper/3rd arm to assist with run-flat and UHP tyres	Option	●	●	●
Quick-change head and plastic demount head	Option	Option	●	-
Plastic jaw covers and inserts for demount head	●	●	●	●
Turntable – 2-speed with 3-phase motor	1 speed	1 speed	1 speed/2 speed	1 speed/2 speed
Clamping range – inner steel wheels (inches)	12-22	12-22	12-24	12-30
Clamping range – outer alloy wheels (inches)	10-20	10-20	10-24	N/A
Maximum tyre width (inches)	12	12	15	15
Maximum wheel diameter (mm)	1000	1000	1000	1200
Power supply	1ph	1ph/3ph	1ph/3ph	1ph
2-year on-site parts and labour warranty	●	●	●	●
On-site training (45 minutes)	●	●	●	●
Country of manufacture	Italy	Italy	Italy	Italy

<sup>†</sup>Based on a five-year lease agreement. Subject to status. Full terms and conditions available on request. Other lease terms and finance options available on request. Offers valid until 30 April 2015. Prices correct at time of going to press: January 2015. Prices exclude VAT, VAT will be applied at current rate. Errors & omissions excluded.

KNOWLEDGE AND EXPERTISE ACROSS THE UK **0845 603 3636**

# Tyre Packages, Geogas 3000

## BRADBURY TYRE PACKAGE

Bradbury Equipment has established a reputation for being one of the leading suppliers of quality garage equipment, with over 110 years of engineering experience in vehicle lifting, brake-testing equipment and now wheel care products.

### WC5301AA + WC5521 – 1 PHASE

- Fully-automatic tyre changer with assist arm
- 12"-23" clamped on the outside  
14"-36" clamped on the inside
- Electronic wheel balancer
- Standard 240V, 1 phase
- Delivery, installation and basic training included



COMPLETE PACKAGE ONLY **£2,695.00**  
WEEKLY FROM ONLY **£14.07<sup>+</sup>**

## WERTHER TYRE PACKAGE

### TITANIUM 200 + OLIMP2500 – 1 PHASE

- Fully-automatic tyre changer with air-operated tilting column and assist arm
- Inside clamping 13" to 24"
- Octagonal self-centering turntable
- 3-phase option with twin speed available (special order)
- Electronic wheel balancer
- Self-diagnosis and self-calibration
- 1 Phase



COMPLETE PACKAGE ONLY **£2,495.00**  
WEEKLY FROM ONLY **£13.03<sup>+</sup>**

\*Based on a five-year lease agreement. Subject to status. Full terms and conditions available on request. Other lease terms and finance options available on request. Offers valid until 30 April 2015. Prices correct at time of going to press: January 2015. Prices exclude VAT, VAT will be applied at current rate. Errors & omissions excluded.

OVER 180 BRANCHES NATIONWIDE **0845 603 3636**

## JOHN BEAN GEOGAS 3000 GAS AND SMOKE TESTER

The John Bean Geogas 3000 Gas and Smoke emissions tester provides the modern workshop with an expandable platform that can grow with your business.

- DVSA approved for MOT testing
- Flat panel 22in monitor with crisp clear graphics
- Monochrome laser jet printer
- Easy maintenance with filters, O2 cell at working height
- Expandable diagnostic capabilities
- Bluetooth connectivity as standard
- Cable-free work space
- Fast warm-up means the unit is ready to use in a matter of seconds
- Can be integrated into a John Bean brake tester
- Can be upgraded to John Bean four-wheel alignment (optional extra)



COMPLETE PACKAGE ONLY **£4,695.00**  
WEEKLY FROM ONLY **£22.03<sup>+</sup>**

## JOHN BEAN T3000-22 AND B9400 PACKAGE

### T3000-22 Tyre Changer

This wdk-certified tyre changer in two-speed technology optimises torque and speed depending on the requirements of mounting and demounting operations. This optimises and accelerates operation and consequently increases productivity.

- Double-acting bead breaker cylinder
- Pneumatic tilt-back post, pneumatically locked in working position
- One-part mounting head vertically and laterally adjustable in spaced-apart position relative to the rim
- Plastic protection on mounting head to avoid damage to alloy rims
- Large bead breaker blade

### B9400 Wheel Balancer

Compact, easy-to-use wheel balancer with small footprint and LED display.

- VPM (virtual plane measuring) for enhanced measuring and higher accuracy results
- Automatic start of measurement when hood is closed and brake applied at end of spin cycle
- Robust 40mm shaft
- Five different options for weight positioning on wheel
- 2D SAPE - automatic entry of wheel diameter and wheel distance
- Split weight mode - hide weights behind wheel spokes for more appealing cosmetic finish
- Tyre matching mode - optimise tyre to rim so using less weights



COMPLETE PACKAGE ONLY **£4,399.00**  
WEEKLY FROM ONLY **£24.22<sup>+</sup>**

# Tyre Packages

## BOSCH TYRE PACKAGE

### TCE 4430 + WBE 4200

One of the world's industry leaders in build and design of tyre service equipment

- Unique Bosch G-Frame concept
- Manufactured in Europe
- Models include Auxiliary helper, Run Flat Arms and Roller board as standard
- Pedal operated Two Speed, bi-directional turntables
- For use in all workshops, higher output fast fits or tyre centres
- Also available in 1ph
- Tyre Changer comes with 4 year standard warranty

#### WBE4200 Balancer

- Space-saving slim design
- Measuring time - just 8 seconds
- New external arm for automatic wheel width measurement
- New automatic detection system to position weights
- Automatic locking of the arm in position
- Digital display



COMPLETE PACKAGE ONLY **£5,495.00**  
WEEKLY FROM ONLY **£28.91<sup>+</sup>**

## BOSCH TYRE PACKAGE

### TCE 4430 + WBE 4400

One of the world's industry leaders in build and design of tyre service equipment

- Unique Bosch G-Frame concept
- Manufactured in Europe
- Models include Auxiliary helper, Run Flat Arms and Roller board as standard
- Pedal operated Two Speed, bi-directional turntables
- For use in all workshops, higher output fast fits or tyre centres
- Also available in 1ph
- Tyre Changer comes with 4 year standard warranty

#### WBE4400 Balancer

- Space-saving slim design
- Measuring time - just 8 seconds
- New external arm for automatic wheel width measurement
- New automatic detection system to position weights
- Automatic locking of the arm in position
- TFT monitor



COMPLETE PACKAGE ONLY **£5,999.00**  
WEEKLY FROM ONLY **£31.56<sup>+</sup>**

\*Based on a five-year lease agreement. Subject to status. Full terms and conditions available on request. Other lease terms and finance options available on request. Offers valid until 30 April 2015. Prices correct at time of going to press: January 2015. Prices exclude VAT, VAT will be applied at current rate. Errors & omissions excluded.

OVER 180 BRANCHES NATIONWIDE 0845 603 3636

NO HASSLE  
WARRANTY

BEST PRICE  
PROMISE

## JOHN BEAN PROFESSIONAL

### T5000 + B9655

#### T5000 Tyre Changer

- Double-acting 2 speed bead breaker cylinder
- Mounting head, vertically and laterally adjustable in spaced-apart position relative to the rim (pneumatically controlled)
- Four self centring turntable jaws
- Mounting head and jaws are provided with plastic protectors
- Ergonomic and user-friendly arrangement of pedals
- Quick-inflating valve
- Outer clamping range up to 24"
- Quick change plastic demount head
- Pneumatic tilt back post, pneumatically locked in working position
- MH320 PRO suited for handling run-flat tyre systems
- Tool box with integrated precision pressure gauge
- Bead breaker blade supported in three joints

#### B9655 Balancer

- Patented virtual plane measurement (VPM) technique
- Automatic input of distance rim/machine and rim diameter (2D SAPE)
- Shortest 'start-stop' cycle time of only 6 seconds for a 15" rim
- 19" TFT monitor with user-friendly graphical interface including pictorials
- Quick Bal for reduced cycle times
- Automatic wheel braking after measurement
- Pedal-operated main shaft lock
- Motor drive via poly v belt ensures constant speed during measuring run
- Compact dimensions allow installation close to a wall



COMPLETE PACKAGE ONLY **£5,999.00**  
WEEKLY FROM ONLY **£31.56<sup>†</sup>**

## JOHN BEAN SHORT LIFT 3.0-TONNE ELECTRO-HYDRAULIC MID-RISE SCISSOR LIFT

- Electro-hydraulic
- 3.0-tonne capacity
- Twin cylinder system
- Maximum lifting height 930mm
- Platform length 1.9m
- Maximum lift width 1770mm (plus toe traps)
- 2-year warranty
- 1 phase



ONLY **£2,995.00**  
WEEKLY FROM ONLY **£16.49<sup>†</sup>**

<sup>†</sup>Based on a five-year lease agreement. Subject to status. Full terms and conditions available on request. Other lease terms and finance options available on request. Offers valid until 30 April 2015. Prices correct at time of going to press: January 2015. Prices exclude VAT, VAT will be applied at current rate. Errors & omissions excluded.

KNOWLEDGE AND EXPERTISE ACROSS THE UK **0845 603 3636**

# John Bean MOT Bay

**NO HASSLE  
WARRANTY**

**BEST PRICE  
PROMISE**



Automated Test Lane workshops need to make the most of their lift bays and maximise revenue, and ATL packages from John Bean provide the right equipment for the job, along with the quality, expertise and service you expect.

Are you looking to upgrade your old MOT bay? We could save you thousands of pounds! Call today for your no-obligation site visit.

Upgrade any of the below packages to include a motorcycle bay for only £995 all with a 2-year warranty

JOHN BEAN ATL		PRICE	WEEKLY FROM*
Class IV 4-post ATL Package	4.0-tonne 4.3m 4-post Lift, 2.0-tonne Jacking Beam, PC-based Brake Tester, Headlight Aligner, Turn Plates, Play Detectors, Cover plates, Mirrors and Brake Pedal Depressor	<b>£19,995.00</b>	<b>£104.42</b>
Class IV Scissor ATL Package	4.0-tonne 4.5m Scissor Lift, 2.0-tonne Jacking Beam, PC-based Brake Tester, Headlight Aligner, Turn Plates, Play Detectors, Cover plates, Mirrors and Brake Pedal Depressor	<b>£26,095.00</b>	<b>£137.30</b>
Class IV & VII 4-post ATL Package	4.0-tonne 5.2m 4-post Lift, 2.8-tonne Jacking Beam, PC-based Brake Tester, Headlight Aligner, Turn Plates, Play Detectors, Cover plates, Mirrors and Brake Pedal Depressor	<b>£25,995.00</b>	<b>£135.75</b>
Class IV & VII Extended 4-post ATL Package	5.0-tonne 5.7m 4-post Lift, 2.8-tonne Jacking Beam, PC-based Brake Tester, Headlight Aligner, Turn Plates, Play Detectors, Cover plates, Mirrors and Brake Pedal Depressor	<b>£27,495.00</b>	<b>£138.37</b>
Class IV & VII Scissor ATL Package	5.0-tonne 5.2m Scissor Lift, 2.8-tonne Jacking Beam, PC-based Brake Tester, Headlight Aligner, Turn Plates, Play Detectors, Cover plates, Mirrors and Brake Pedal Depressor	<b>£31,995.00</b>	<b>£167.09</b>
<b>NEW</b> Class IV Dual Revenue 4 Post Package	4 Post ATL/Alignment Lift, 2.0-tonne jacking beam, PC-based Brake Tester, Headlight Aligner, Turn Plates, Rear Slip Plates, Play Detectors, Cover Plates, Mirrors and Brake Pedal Depressor	<b>£21,995.00</b>	<b>£115.73</b>
Class IV Dual Revenue Scissor Package	Scissor ATL/Alignment Lift, 2.0-tonne jacking beam, PC-based Brake Tester, Headlight Aligner, Turn Plates, Rear Slip Plates, Play Detectors, Cover Plates, Mirrors and Brake Pedal Depressor	<b>£26,845.00</b>	<b>£141.25</b>

\*Based on a five-year lease agreement. Subject to status. Full terms and conditions available on request. Other lease terms and finance options available on request. Offers valid until 30 April 2015. Prices correct at time of going to press: January 2015. Prices exclude VAT, VAT will be applied at current rate. Errors & omissions excluded.

OVER 180 BRANCHES NATIONWIDE **0845 603 3636**





## CRYPTON OFFER A WIDE RANGE OF AUTOMATIC TEST LANES FOR MOT TESTING

UPGRADE ANY OF THE PACKAGES BELOW TO INCLUDE WIRELESS SMOKEMETER FOR JUST **£499**.

Call us to add Class I & II for the packages below at a special price.

Crypton offer both platform scissor lifts and 4-post lifts, finished with high-quality checker plates. The scissor lift is recessed to leave a flush surface when not in use and the absence of posts can save a metre in width of valuable workshop space, making this the ideal choice for smaller garages. The 4-post lift is delivered complete with turn plates and both lifts are VOSA-approved for MOT testing of Class IV and Class VII vehicles.

CLASS IV & VII ATL PACKAGE		PRICE	WEEKLY FROM*
Class IV Pit Package	2.0-tonne Jacking Beam, PC-based Brake Tester, integrated cabled combined Emissions Analyser, Headlight Aligner, Turn Plates, Play Detectors, Mirrors and Brake Pedal Depressor	<b>£17,995.00</b>	<b>£94.68</b>
Class IV 4-post ATL Package	4.0-tonne 4.5m 4-post Lift, 2.0-tonne Jacking Beam, PC-based Brake Tester, integrated cabled combined Emissions Analyser, Headlight Aligner, Turn Plates, Play Detectors, Mirrors and Brake Pedal Depressor	<b>£22,999.00</b>	<b>£121.01</b>
Class IV Scissor ATL Package	4.0-tonne 4.5m Scissor Lift, 2.0-tonne Jacking Beam, PC-based Brake Tester, integrated cabled combined Emissions Analyser, Headlight Aligner, Turn Plates, Play Detectors, Mirrors and Brake Pedal Depressor	<b>£23,995.00</b>	<b>£126.29</b>
Class IV & VII Pit Package	2.8-tonne Jacking Beam, PC-based Brake Tester, integrated cabled combined Emissions Analyser, Headlight Aligner, Turn Plates, Play Detectors, Mirrors and Brake Pedal Depressor	<b>£21,999.00</b>	<b>£115.75</b>
Class IV & VII 4-post ATL Package	5.0-tonne 5.7m 4-post Lift, 2.8-tonne Jacking Beam, PC-based Brake Tester, integrated cabled combined Emissions Analyser, Headlight Aligner, Turn Plates, Play Detectors, Mirrors and Brake Pedal Depressor	<b>£24,995.00</b>	<b>£131.51</b>
Class IV & VII Scissor ATL Package	5.0-tonne 5.5m Scissor Lift, 2.8-tonne Jacking Beam, PC-based Brake Tester, integrated cabled combined Emissions Analyser, Headlight Aligner, Turn Plates, Play Detectors, Mirrors and Brake Pedal Depressor	<b>£29,395.00</b>	<b>£154.66</b>

\*Based on a five-year lease agreement. Subject to status. Full terms and conditions available on request. Other lease terms and finance options available on request. Offers valid until 30 April 2015. Prices correct at time of going to press: January 2015. Prices exclude VAT, VAT will be applied at current rate. Errors & omissions excluded.

# Liftmaster ATL

NO HASSLE  
WARRANTY

BEST PRICE  
PROMISE



Liftmaster provides robust and reliable products at best-value prices.

LIFTMASTER ATL		PRICE	WEEKLY FROM*
Class IV Pit Package	2.0-tonne Jacking Beam, PC-based Brake Tester, Headlight Aligner, Turn Plates, Play Detectors, Mirrors and Brake Pedal Depressor	<b>£16,495.00</b>	<b>£86.14</b>
Class IV 4-post ATL Package	4.0-tonne 4.6m 4-post Lift, 2.0-tonne Jacking Beam, PC-based Brake Tester, Headlight Aligner, Turn Plates, Play Detectors, Mirrors and Brake Pedal Depressor	<b>£19,995.00</b>	<b>£104.42</b>
Class IV Extended 4-post ATL Package	4.0-tonne 5.0m 4-post Lift, 2.0-tonne Jacking Beam, PC-based Brake Tester, Headlight Aligner, Turn Plates, Play Detectors, Mirrors and Brake Pedal Depressor	<b>£21,495.00</b>	<b>£112.25</b>
Class IV & VII Pit Package	2.8-tonne Jacking Beam, PC-based Brake Tester, Headlight Aligner, Turn Plates, Play Detectors, Mirrors and Brake Pedal Depressor	<b>£17,995.00</b>	<b>£93.98</b>
Class IV & VII 4-post ATL Package	5.0-tonne 5.7m 4-post Lift, 2.8-tonne Jacking Beam, PC-based Brake Tester, Headlight Aligner, Turn Plates, Play Detectors, Mirrors and Brake Pedal Depressor	<b>£22,795.00</b>	<b>£119.04</b>
Class IV & VII Extended 4-post ATL Package	5.0-tonne 6.0m 4-post Lift, 2.8-tonne Jacking Beam, PC-based Brake Tester, Headlight Aligner, Turn Plates, Play Detectors, Mirrors and Brake Pedal Depressor	<b>£25,995.00</b>	<b>£135.75</b>
Class IV Scissor Lift ATL Package	4.0-tonne Scissor 4.5mt platform lift, PC brake tester, headlight aligner, 2.0-tonne jacking beam, play detectors, radius plates, mirrors and pedal depressor.	<b>£23,995.00</b>	<b>£126.25</b>
Class IV & VII Scissor Lift ATL Package	5.0-tonne Scissor 5.4mt platform lift, PC brake tester, headlight aligner, 2.8-tonne jacking beam, play detectors, radius plates, mirrors and pedal depressor.	<b>£31,545.00</b>	<b>£165.98</b>

\*Based on a five-year lease agreement. Subject to status. Full terms and conditions available on request. Other lease terms and finance options available on request. Offers valid until 30 April 2015. Prices correct at time of going to press: January 2015. Prices exclude VAT, VAT will be applied at current rate. Errors & omissions excluded.

OVER 180 BRANCHES NATIONWIDE 0845 603 3636



Tecalemit is the UK's longest established supplier of MOT Testing equipment offering the most comprehensive range of technically advanced VOSA approved equipment. Each of our principal items of equipment has been developed to provide time saving features to ensure that the test lane operates at optimum output.

MOT/OPTL AND ATL TESTING EQUIPMENT		PRICE	WEEKLY FROM*
Tecalemit Class IV 4 Post ATL Package	Class IV ATL Package with 4.5T 4 Post 4.58m Platform Lift 2.0-tonne Jacking Beam, PC-based Brake Tester, Headlight Aligner, Turn Plates, Rear Slip Plates, Play Detectors, Cover plates, Mirrors and Brake Pedal Depressor	<b>£19,995.00</b>	<b>£104.40</b>
Tecalemit Class IV Scissor ATL Package	Class IV ATL Package with 5T 4 Post 4.5m Scissor Lift 2.0-tonne Jacking Beam, PC-based Brake Tester, Headlight Aligner, Turn Plates, Rear Slip Plates, Play Detectors, Cover plates, Mirrors and Brake Pedal Depressor	<b>£22,350.00</b>	<b>£117.60</b>
Tecalemit Class IV & VII 4 Post ATL Package	Class VII ATL Package with 5T 4 Post 5.7m Platform Lift 2.8-tonne Jacking Beam, PC-based Brake Tester, Headlight Aligner, Turn Plates, Rear Slip Plates, Play Detectors, Cover plates, Mirrors and Brake Pedal Depressor	<b>£23,945.00</b>	<b>£125.99</b>
Tecalemit Class IV & VII 4 Post Extended Platforms ATL Package	Class VII ATL Package with 5T 4 Post 6.5m Platform Lift 2.8-tonne Jacking Beam, PC-based Brake Tester, Headlight Aligner, Turn Plates, Rear Slip Plates, Play Detectors, Cover plates, Mirrors and Brake Pedal Depressor	<b>£25,995.00</b>	<b>£136.77</b>

\*Based on a five-year lease agreement. Subject to status. Full terms and conditions available on request. Other lease terms and finance options available on request. Offers valid until 30 April 2015. Prices correct at time of going to press: January 2015. Prices exclude VAT, VAT will be applied at current rate. Errors & omissions excluded.

# Bradbury ATL

NO HASSLE  
WARRANTY

BEST PRICE  
PROMISE

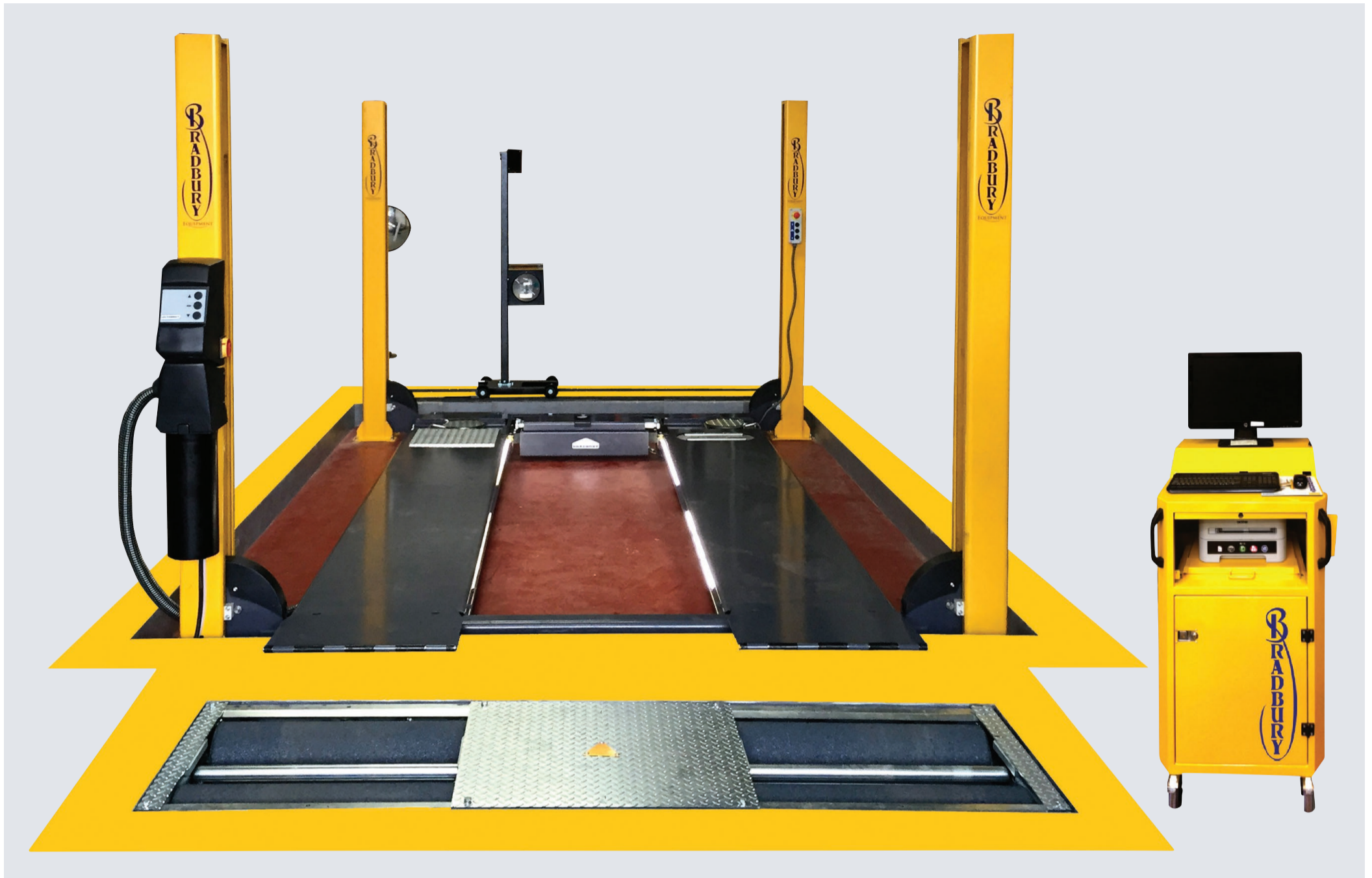

Bradbury offers an amazing array of ATL configurations, with lifts which can be set to variable platform lengths, and the unique hybrid lift. Don't compromise on your ATL layout.



BRADBURY MOT/ATL TESTING PACKAGE		PRICE	WEEKLY FROM <sup>†</sup>
Bradbury Class IV ATL Pit Package	PC-based Brake Tester, Radius Plate, Play Detectors, 2.0 tonne Jacking Beam, Headlight Aligner, Mirrors, Brake Pedal Depressor	<b>£17,045.00</b>	<b>£89.68</b>
Bradbury Class IV ATL 4 Post ATL Package	4 tonne 4.8m 4 Post Lift, PC-based Brake Tester, 2.0 tonne Jacking Beam, Headlight Aligner, Mirrors, Brake Pedal Depressor	<b>£22,695.00</b>	<b>£119.41</b>
Bradbury Class IV ATL Scissor Package	4.5 tonne 4.5m Scissor Lift, PC-based Brake Tester, 2.0 tonne Jacking Beam, Headlight Aligner, Mirrors, Brake Pedal Depressor	<b>£28,295.00</b>	<b>£143.85</b>
Bradbury Class IV & VII ATL 4 Post Package	4.5 tonne 5.45m 4 Post Lift, PC-based Brake Tester, 2.0 tonne Jacking Beam, Headlight Aligner, Mirrors, Brake Pedal Depressor	<b>£25,495.00</b>	<b>£134.14</b>
Bradbury Class IV & VII Hybrid Lift ATL Package	4.5 tonne 5m Hybrid Lift, PC-based Brake Tester, 2.0 tonne Jacking Beam, Headlight Aligner, Mirrors, Brake Pedal Depressor	<b>£31,195.00</b>	<b>£164.13</b>

<sup>†</sup>Based on a five-year lease agreement. Subject to status. Full terms and conditions available on request. Other lease terms and finance options available on request. Offers valid until 30 April 2015. Prices correct at time of going to press: January 2015. Prices exclude VAT, VAT will be applied at current rate. Errors & omissions excluded.

OVER 180 BRANCHES NATIONWIDE 0845 603 3636



Order a stand alone Motorcycle MOT Bay and receive a FREE multi makes MOT stand, covers all manufacturers and models worth £ 387.00  
Multimakes MOT inspection stand and adaptor kit worth £ 387.00 + vat  
**FREE** with every stand alone motorcycle MOT bay - while stocks last!



RS WORKSHOP EQUIPMENT		PRICE	WEEKLY FROM*
Standalone Motorcycle MOT Package	Includes Brake Tester with Remote & Weighing, Headlamp Tester & Rail Set, Wheel Alignment Bars, Ancillary Pack, Decelerometer	<b>£7,945.00</b>	<b>£39.44</b>

UPGRADE YOUR EXISTING MOT BAY TO INCLUDE MOTORCYCLE MOT TESTING FROM JUST **£1,749**

Call us to discuss packages, ask for details specific to your premises!

\*Based on a five-year lease agreement. Subject to status. Full terms and conditions available on request. Other lease terms and finance options available on request. Offers valid until 30 April 2015. Prices correct at time of going to press: January 2015. Prices exclude VAT, VAT will be applied at current rate. Errors & omissions excluded.

# MOT Essentials

## BEA 850 COMBI EMISSION ANALYSER

BEA 850 for petrol and diesel vehicles. Testing and minimising pollutant emissions with modular measurement technology – in accordance with the latest legislation and with high measurement accuracy.

- Optimized for all exhaust-gas test requirements
- Integrated on-board diagnostics (OBD) with control unit diagnostic testers of the KTS series
- Integrated on a workshop-compatible trolley
- 4-gas module with optional nitrogen oxide
- Very rapid response time thanks to optimized flow performance
- Gas detectors with high measurement accuracy and long-term stability
- Simple equipment maintenance by workshop staff
- 5-year care plan (optional)
- 2-year warranty
- KTS not included



ONLY **£4,995.00**  
WEEKLY FROM ONLY **£27.50<sup>+</sup>**

## BEA 350 COMBI EMISSION ANALYSER

BEA 350 Combination petrol and diesel emissions analyser. A complete exhaust emissions tester for cars and commercial vehicles in one compact unit. Fully compliant with all MOT testing and swipe-card ready.

- Processor-based emission testing equipment
- Fully approved for MOT testing of petrol and diesel emissions
- Fully compatible for swipe card technology
- Measuring accuracy to OIML R99, class 0
- Simple step-by-step operation
- Brilliant colour TFT screen
- 5-year care plan (optional)
- 2-year warranty



ONLY **£3,995.00**  
WEEKLY FROM ONLY **£22.00<sup>+</sup>**

## CRYPTON 800 EMISSIONS ANALYSER

The CCP800 series is UK manufactured integrated gas and smoke analyser combining state of the art digital technology. This unit complies with the latest DVSA regulations and comes complete with the following:

- Oil temperature probe
- Battery RPM Measurement (petrol & diesel)
- Colour A4 printer
- 23" IBA Widescreen monitor
- All housed in a high quality roll-round cabinet
- Integral keyboard cover for dust/grease protection
- 3 year on-site parts and labour warranty
- 3 or 5 year Care Packages available

Updating is easy - the annual DVSA petrol vehicle update and any changes to the program procedure/test limits can be done simply by loading a disk, no service visit is necessary.



ONLY **£4,395.00**  
WEEKLY FROM ONLY **£24.20<sup>+</sup>**

Cabled version. Bluetooth version also available.

## PREMIER COMBI EMISSION ANALYSER

British built combined petrol and diesel emission analyser with integrated oil temperature and unique RPM measurement technology.

- Every MOT testis stored to memory for instant retrieval and automatic printout of customer reminder letters.
- Wi-Fi enabled PC with flexibility to run own programmes, CD Rom, 17 inch colour monitor, keyboard, mouse and printer
- Fast nationwide on-site support by dedicated UKAS accredited engineers
- **3 year Care Package included**



ONLY **£4,995.00**  
WEEKLY FROM ONLY **£27.50<sup>+</sup>**



## LAUNCH CODE READER PRO 129

- Retrieve vehicle information ( VIN, CIN, CVN )
- Read and Clear Fault Codes
- Read & Clear 'Check Engine' Lights
- All 10 OBDII Tests
- Turn off Malfunction Indicator Lamps, and reset monitors
- Oil & Parking Brake Reset
- Print data via PC

COMPLETE UNIT ONLY **£269.00**

\*Based on a five-year lease agreement. Subject to status. Full terms and conditions available on request. Other lease terms and finance options available on request. Offers valid until 30 April 2015. Prices correct at time of going to press: January 2015. Prices exclude VAT, VAT will be applied at current rate. Errors & omissions excluded.

OVER 180 BRANCHES NATIONWIDE **0845 603 3636**

**NO HASSLE WARRANTY**

**BEST PRICE PROMISE**

## JACKING BEAMS



- Supplied with a double-extending top beam as standard - **New Feature**
- Low height to suit vehicles with low clearance - **New Feature**
- Support arms available to suit all makes of lift (POA)\*
- Ultra-low jacking position
- 5-year warranty

\*Special arms will be charged at extra cost

**MANUAL 2.0 TONNE ONLY £799.00**

**MANUAL 2.8 TONNE ONLY £1,095.00 WEEKLY FROM ONLY £5.72<sup>†</sup>**

## UNIVERSAL SOLID RUBBER RAISER BLOCKS

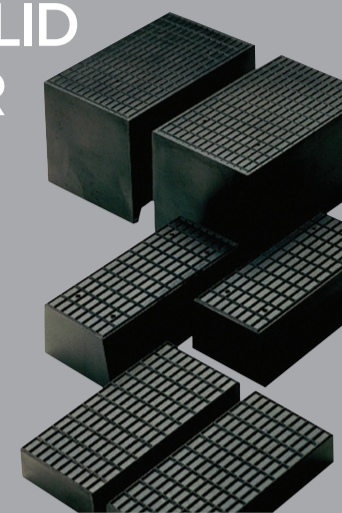

DIMENSIONS mm (HxWxD)	PART NO.	PRICE
40 x 200 x 100	1590S	<b>£29.00 Pair</b>
70 x 200 x 100	1590M	<b>£39.00 Pair</b>
120 x 230 x 140	1590L	<b>£59.00 Pair</b>
Full Set (2 of each size)		<b>£99.00</b>

New wider top beam to reach the designated lifting points on modern vehicles (e.g. BMW, Mercedes-Benz).

New higher lifting height for high ground clearance vehicles (e.g. Land Rover).

New versatile package price, same BESPOKE product - supplied to fit your lift like a glove and hit all the right spots on the vehicle chassis.

Manual 2.0 Ton Package	Includes set of Aluminium tall raiser blocks worth £59; bespoke arms to fit your lift worth up to £110	<b>£799.00</b>	<b>£4.40</b>
Manual 2.8 Ton Package	Includes set of Aluminium tall raiser blocks worth £59; bespoke arms to fit your lift worth up to £110	<b>£1,095.00</b>	<b>£5.95</b>
Air 2.0 Ton Package	Includes set of Aluminium tall raiser blocks worth £59; bespoke arms to fit your lift worth up to £110	<b>£1,199.00</b>	<b>£6.60</b>
Air 2.8 Ton Package	Includes set of Aluminium tall raiser blocks worth £59; bespoke arms to fit your lift worth up to £110	<b>£1,345.00</b>	<b>£7.41</b>

## MOT-RELATED TOOLS AND ANCILLARIES

### EASY-ON KEY TAGS

Strong and economical with a unique click-fixing method.

- Fastens onto the thickest of keys
- 82 x 22mm writing surface
- Write on with any pen or pencil
- 1500 per box, white only

**ONLY £45.00**

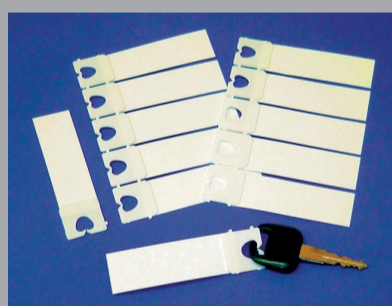

### INTERIOR & EXTERIOR SIGN PACK

Printed with fade-proof inks on weather-resistant panels. Includes: MOT 3-Triangles, Diesels Tested, Catalysts Tested, MOT Viewing Area, MOT Viewing Area Available, MOT Reception and Waiting Area, MOT Test Bay and MOT Parking x2.

**ONLY £56.00**

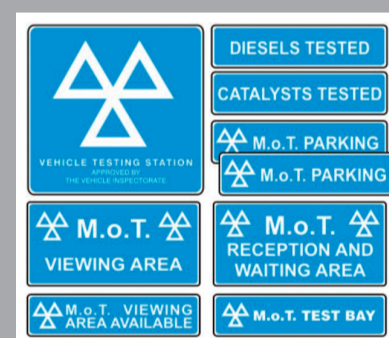

### MOT TOOL STORAGE SHADOW PANEL

See your MOT tools at a glance and promote an organised image – the VOSA inspectors love them! Can be supplied with or without the mandatory MOT tools, which can also be purchased separately.

**ONLY £75.00 WITH TOOLS ONLY £30.00 WITHOUT TOOLS**

### BOWMONK ELECTRONIC DECELEROMETER

- VOSA Approved for MOT Testing
- Suitable for Cars, 4x4s, Motorcycles (additional bracket required), LCV, HGV, Bus & Coach
- Measures Service & Handbrake efficiency as part of the MOT
- Wireless printer capability

**ONLY £345.00**



### TAPLEY ELECTRONIC BRAKE METER

- VOSA Approved for MOT Testing
- Suitable for Cars & Motorcycles (additional bracket also required)
- Measures Service & Handbrake efficiency as part of the MOT

**ONLY £229.00**

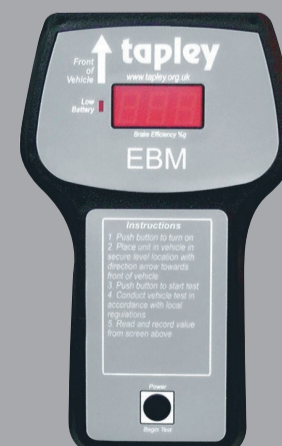

<sup>†</sup>Based on a five-year lease agreement. Subject to status. Full terms and conditions available on request. Other lease terms and finance options available on request. Offers valid until 30 April 2015. Prices correct at time of going to press: January 2015. Prices exclude VAT, VAT will be applied at current rate. Errors & omissions excluded.

KNOWLEDGE AND EXPERTISE ACROSS THE UK **0845 603 3636**

# Air Compressors

## PRO A29B 150 CM3 small portable compressor

- Belt driven • 11.2 cfm (displacement)
- 10 bar • 50-litre tank
- 1 phase

ONLY **£425.00**



## PRO A39B 150 FM3

- Belt driven • 13.8 cfm (displacement)
- 10 bar • 150-litre tank
- 1 phase

ONLY **£545.00**



## PRO A39B 200 FM3

- Belt driven • 13.8 cfm (displacement)
- 10 bar • 200-litre tank
- 1 phase

ONLY **£595.00**



## PRO B4900 200 FT4

- Belt driven • 18 cfm (displacement)
- 11 bar • 200-litre tank
- 3 phase

ONLY **£695.00**



## PRO B5900B 200 FT5.5

- Belt driven • 22.9 cfm (displacement)
- 11 bar • 200-litre tank
- 3 phase

ONLY **£825.00**



## PRO A39B 270 FM3 TANDEM

The Tandem runs 2 x 3hp compressors on a single receiver to enable customers who only have single phase electrics to obtain more output

- Belt driven • 27.6 cfm (displacement) (20.2 cfm free air delivered)
- 10 bar • 150-litre tank • 1 phase

ONLY **£1,325.00**  
WEEKLY FROM ONLY **£6.92<sup>+</sup>**



## ENGINEAIR HP4 AIR COMPRESSOR

### ENGINEAIR 5/50 PETROL

- Mobile
- 4.8 Hp Honda engine
- 10 bar
- 12 cfm (displacement)
- 50-litre tank

ONLY **£895.00**

### ENGINEAIR 5/200 PETROL

- Mobile
- 4.8 Hp Honda engine
- 10 bar
- 12 cfm (displacement)
- 200-litre tank

ONLY **£995.00**



\*Based on a five-year lease agreement. Subject to status. Full terms and conditions available on request. Other lease terms and finance options available on request. Offers valid until 30 April 2015. Prices correct at time of going to press: January 2015. Prices exclude VAT, VAT will be applied at current rate. Errors & omissions excluded.

OVER 180 BRANCHES NATIONWIDE 0845 603 3636



**NO HASSLE  
WARRANTY**

**BEST PRICE  
PROMISE**

## SCREW COMPRESSORS

- Unique technology – fitted with the latest generation rotary screw compressor air end
- Efficient – high output with very low power consumption
- Simple, advanced design – lower maintenance costs
- Extremely compact – simple to install
- Engineered to last – rugged & reliable
- Dryer option available



SCREW COMPRESSOR MODEL	PRESSURE		CAPACITY (ISO 1217)		MOTOR		NOISE LEVEL dB(A)	RECEIVER (l)	POWER SUPPLY	PRICE	WEEKLY FROM†
	Bar	Psi	l/min	CFM	HP	kW					
SPINN 2.2 10 200	10	145	240	8.5	3	2.2	61	200	230V or 400V	£2,345.00	£12.91
SPINN 410 10 200	10	145	470	16.6	5.5	4	62	200	400V	£2,495.00	£13.74
SPINN 5.5 10 270	10	145	600	21.2	7.5	5.5	64	270	400V	£2,895.00	£15.94
SPINN E 5.5 10 270 with drier	10	145	600	21.2	7.5	5.5	64	270	400V	£3,295.00	£18.14

## GENESIS SCREW COMPRESSORS - DRYER & FILTER INCLUDED

- Integrated Air Workstation - with compressor, refrigerant dryer, automatic drain, line filter and receiver
- Full control and functionality with just a few clicks using the intuitive smart controller
- Space efficient design
- Extreme low noise level
- Low maintenance, low energy consumption, low service input
- Enhanced efficiency and lifetime



SCREW COMPRESSOR MODEL	PRESSURE		CAPACITY (ISO 1217)		MOTOR		NOISE LEVEL dB(A)	WEIGHT KG	POWER SUPPLY	PRICE	WEEKLY FROM†
	Bar	Psi	m <sup>3</sup> /min	CFM	HP	kW					
Genesis 7.5 08 270 V400	8	116	1.153	40.7	10	7.5	66	390	400V	£4,295.00	£23.65
Genesis 11 08 270 V400	8	116	1.665	58.8	15	11	69	355	400V	£4,695.00	£25.86
Genesis 15 08 270 V400	8	116	1.985	70.1	20	15	69	380	400V	£4,895.00	£26.96

†Based on a five-year lease agreement. Subject to status. Full terms and conditions available on request. Other lease terms and finance options available on request. Offers valid until 30 April 2015. Prices correct at time of going to press: January 2015. Prices exclude VAT, VAT will be applied at current rate. Errors & omissions excluded.

KNOWLEDGE AND EXPERTISE ACROSS THE UK **0845 603 3636**

# 4-Post Lifts

NO HASSLE  
WARRANTY

BEST PRICE  
PROMISE

## JOHN BEAN EHL 3500 4P-JB

- Electro-hydraulic operation
- Overload safety valve
- Descent control valve
- Buzzer on last portion of descent
- Pipe burst safety valve
- 24V low tension 'dead man' controls
- Automatic release of safety locking devices
- Manufactured in Europe
- 2 Year warranty

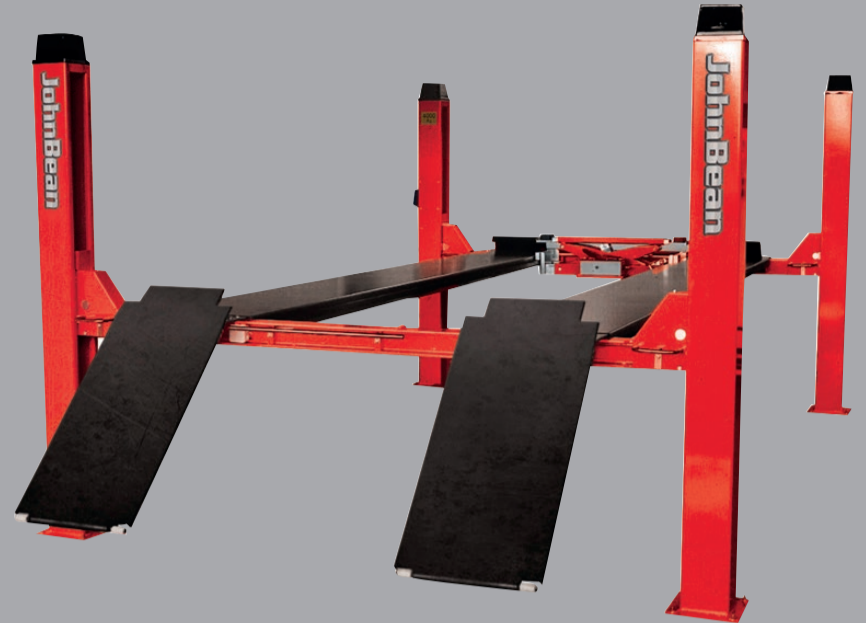

FROM ONLY **£4,595.00** for 3 phase versions (add £395 for 1 phase version)  
WEEKLY FROM ONLY **£25.31<sup>†</sup>**

## BENDPAK HD-9XW

- 4.0-tonne capacity
- Robust and reliable
- Runways accommodate wide or narrow vehicles
- 3 phase (1 phase option available at no extra cost)
- 1-year full warranty

### FREE 2 TON JACKING BEAM

Whilst stocks last



(For illustration only - actual jacking beam may differ)

ONLY **£3,895.00**  
WEEKLY FROM ONLY **£21.45<sup>†</sup>**



## TECALEMIT SF9084

- 4.0-tonne electro-hydraulic
- 5 metre platform length
- Suitable for general servicing & repairs
- Suitable for long wheel base vans
- Manufactured in Europe
- Compact space saving design

### FREE 2 TON JACKING BEAM

Whilst stocks last



(For illustration only - actual jacking beam may differ)

ONLY **£4,595.00**  
WEEKLY FROM ONLY **£25.31<sup>†</sup>**



<sup>†</sup>Based on a five-year lease agreement. Subject to status. Full terms and conditions available on request. Other lease terms and finance options available on request. Offers valid until 30 April 2015. Prices correct at time of going to press: January 2015. Prices exclude VAT, VAT will be applied at current rate. Errors & omissions excluded.

OVER 180 BRANCHES NATIONWIDE 0845 603 3636

# Scissor Lifts

NO HASSLE  
WARRANTY

BEST PRICE  
PROMISE

## BRADBURY H8603E 3.6-TONNE IN-GROUND SCISSOR LIFT

- Flush-fitted
- Ratchet Locking Mechanism
- Hydraulically synchronised platforms
- Low voltage control system
- Full access to sides, front and rear of vehicle
- Includes platform extensions
- Hydraulic platforms synchronization
- Safety valves detects hydraulic failure
- Overload mechanical safety device
- Reflector/light beam sensor ensures platform remains level throughout
- Only £ 195 more with a 1 phase motor



FROM ONLY **£3,795.00**  
WEEKLY FROM ONLY **£20.90<sup>+</sup>**

## BRADBURY H8903E 3.2-TONNE SURFACE-MOUNTED SCISSOR LIFT

- Hydraulically-synchronised platforms
- Full access to sides, front and rear of vehicle
- Ideal for service bays, tyre shops, body shops, general repairs, brake repairs, suspension and transmission replacement
- Low-profile platform ideal for a large range of vehicles
- 3 phase (1 phase option available)
- 1-year full warranty

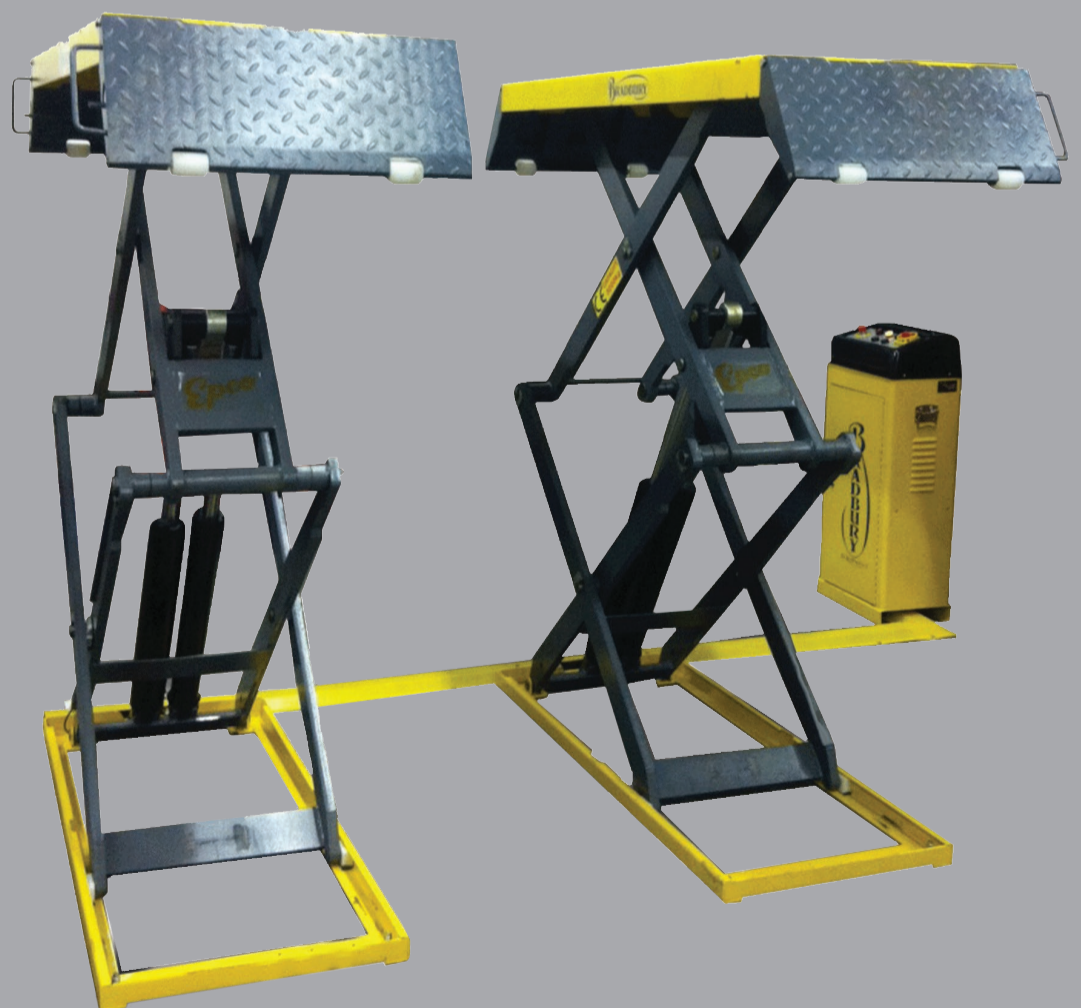

ONLY **£3,795.00**  
WEEKLY FROM ONLY **£20.90<sup>+</sup>**

\*Based on a five-year lease agreement. Subject to status. Full terms and conditions available on request. Other lease terms and finance options available on request. Offers valid until 30 April 2015. Prices correct at time of going to press: January 2015. Prices exclude VAT, VAT will be applied at current rate. Errors & omissions excluded.

KNOWLEDGE AND EXPERTISE ACROSS THE UK **0845 603 3636**

# 2 Post Lifts

## BENDPAK XPR9T

- 4.0-tonne lifting capacity
- Triple-reach arms front and rear
- 3 year warranty
- New adjustable-width design for narrow or wide configuration
- 1 or 3 phase – same price

ONLY **£2,895.00**  
WEEKLY FROM ONLY **£15.94<sup>†</sup>**



## LIFTMASTER LM3500

- Hydraulic 2 post
- 3.5-tonne lifting capacity
- Double screw adjustment pads
- 1-year full warranty
- 3-year parts warranty
- 1 or 3 phase - same price

ONLY **£2,195.00**  
WEEKLY FROM ONLY **£12.09<sup>†</sup>**



## JOHN BEAN SOL 3000

- 2-post lift for vehicles up to 3.0 tonnes
- Perfect ground clearance – no base frame
- Asymmetrical design, car door access on two sides
- Automatic arm locks
- Low pick-up height
- Electro-mechanical drive
- Rugged long-life column profile
- Rolled-thread lifting spindles
- Automatic lubrication system
- 4 pick-up pads vertically adjustable from approximately 98-140mm, 120mm diameter
- Two mechanically-synchronised drive motors
- 3 phase
- 2-year full warranty

ONLY **£2,850.00**  
WEEKLY FROM ONLY **£15.69<sup>†</sup>**



<sup>†</sup>Based on a five-year lease agreement. Subject to status. Full terms and conditions available on request. Other lease terms and finance options available on request. Offers valid until 30 April 2015. Prices correct at time of going to press: January 2015. Prices exclude VAT, VAT will be applied at current rate. Errors & omissions excluded.

OVER 180 BRANCHES NATIONWIDE **0845 603 3636**

NO HASSLE  
WARRANTY

BEST PRICE  
PROMISE

## JOHN BEAN EHL 3200-JB ASYMMETRIC ELECTRO-HYDRAULIC 2-POST LIFT WITH SINGLE RAM

- 3.2-tonne capacity
- Electro-mechanical safety locking device in case of rope failure
- Automatic arm locking device
- Foot guards
- Overload safety device
- Descent control valve
- Parachute valve
- 'Dead Man' controls, 24V
- Mechanical synchronisation
- 3 phase (1 phase option available)
- 2-year full warranty

FROM ONLY **£3,445.00** for 3 phase versions (add £395 for 1 phase version)  
WEEKLY FROM ONLY **£18.97<sup>†</sup>**



## LIFTMASTER LMS3000

- European Manufactured
- 3 Ton lifting capacity
- Very low pick up height
- CE & TUV approved – VW, BMW & Mercedes versions available
- Two widths available
- Twin motor
- Electronically synchronised carriages
- Communication cables between posts may be laid beneath floor or inside ceiling if gantry is not desired
- Available with extra low-entry lifting arms configuration ( LMS3000TRA )

ONLY **£2,595.00**  
WEEKLY FROM ONLY **£14.28<sup>†</sup>**



## LIFTMASTER XPR10T

- 4.5 Ton Lifting capacity
- Available with 1 or 3 phase motor
- Expandable top beam accommodates wide or narrow configurations
- Drop-end arms provide a lower pad height
- Dual hydraulic direct-drive cylinders
- Single-point safety release
- Safety locks in each column spaced every 3"
- Automatic arm restraints
- 8-piece truck and van adapter set standard
- Triple-telescoping arms
- ETL & CE approved
- 3 Year warranty

ONLY **£3,095.00**  
WEEKLY FROM ONLY **£17.04<sup>†</sup>**



<sup>†</sup>Based on a five-year lease agreement. Subject to status. Full terms and conditions available on request. Other lease terms and finance options available on request. Offers valid until 30 April 2015. Prices correct at time of going to press: January 2015. Prices exclude VAT, VAT will be applied at current rate. Errors & omissions excluded.

KNOWLEDGE AND EXPERTISE ACROSS THE UK 0845 603 3636

# Boosters and Autodata

**NO HASSLE  
WARRANTY**

**BEST PRICE  
PROMISE**

## POWERVAMP TECHNOBOOST 1600

The compact 12-volt starter pack for professionals in the motor trade, perfect for car dealerships, workshops and body shops.

British-designed and built, the pack uses one of the same very powerful batteries as used in Powervamp's 24-volt small jet turbine aircraft and helicopter packs.

- Nominal power cell – peak amps 1600
- 235 amp
- Surge protection
- Reverse polarity warning
- Key switch isolator
- LED power status
- Exceptionally strong fully-insulated case
- 2-metre long output leads



**ONLY £245.00** 592 77 2240

## POWERVAMP MR26

The ever-popular 12-volt MR26 has proven itself time and time again whether it's in an auction house, car park or commercial garage. The robust MR26 is ideal for starting large diesel engines (vans, 4x4's, mini-buses etc), up to 3.5 litres, as well as petrol engines up to 7.0 litres.

All Powervamp products are designed and manufactured in the UK with full technical support and servicing available.

- Nominal power cell – peak amps 2400
- 370 CCA
- Surge protection
- Reverse polarity warning
- Key switch isolator
- LED charger status
- IEC mains charging lead
- 2-metre fully-insulated output leads
- Optional On-Board Charge Kit (OBCK)



**ONLY £295.00** 592 77 2250

## POWERVAMP TB1224HDD

Tough 12v/24v jump-starter designed for frequent starting of commercial vehicles. The TB1224HDD is intended for heavy or regular 12 or 24 volt use. ideal for fleet users, operating diesels typically up to 15 litres.

- Twin 3 stage, 2.3 amp internal chargers
- Cast and braid crocodile clips
- Tri-coloured battery charge status LEDs
- Robust powder-coated steel case
- Detachable 2 metre heavy duty cable set
- Anti-surge protection PCB
- Battery Management



**ONLY £635.00** 592 77 2320

## AUTODATA ONLINE

Autodata are a World Leader in technical data to the Automotive Aftermarket. An Autodata subscription means access to the most Accurate, Relevant, and Up-To-Date manufacturers' information needed for complete service, repair and diagnostic work. Make work more profitable with Autodata's NEW online products



Designed around the user, the new online platform creates a business-focused tool to:

- Reduce time spent at the computer
- Provide real-time updates of all data and components
- Allow a new level of interactive diagrams

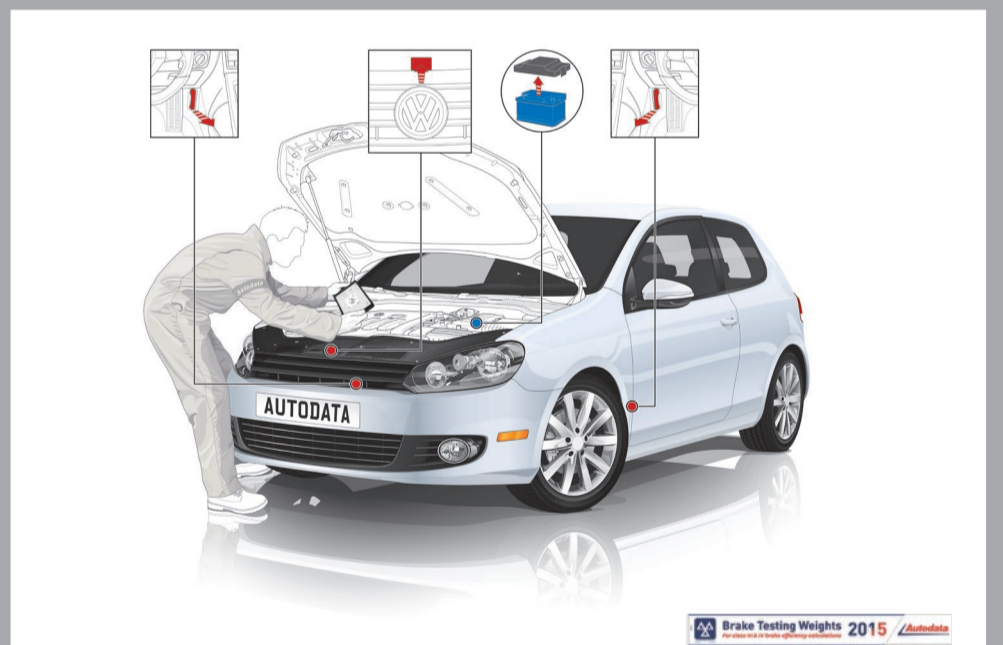

12 MONTHS ONLINE SUBSCRIPTION  
AUTODATA DIAGNOSTIC & REPAIR  
ONLY **£720.00**

12 MONTHS ONLINE  
SUBSCRIPTION AUTODATA  
SERVICE & MAINTENANCE  
ONLY **£420.00**

AUTODATA MOT  
WALLCHARTS 5  
CHART PACK  
ONLY **£79.50**

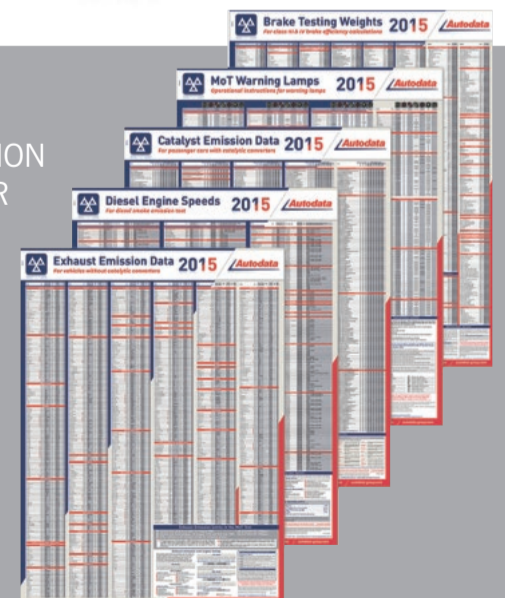

## SMOKE PRO® – TOTAL TECH®

The choice for professionals to fix leaks FAST. The Smoke Pro® EVAP-approved diagnostic smoke machines are the most advanced available today.

### SAVING TIME = MORE PROFITS

The Smoke Pro® Total Tech® is the essential tool for finding EVAP system leaks and many others including:

- EGR Valves
- Gaskets, fittings and hoses
- MAP/MAF sensors
- Worn throttle shafts
- Brake boosters

- Catalytic converters
- Central locking systems
- Diaphragms and seats
- Door and window seals
- Turbos and intercoolers
- Oil leaks
- Cracked or broken plastic components
- Head and tail lamp housings
- Cracked manifolds.

And many more!



ONLY **£659.00**

## SMOKE PRO® – AIR COMPLETE™

### PORTABILITY = PROFITABILITY

- On-board micro air compressor eliminates the need for air lines or gas tanks
- Extra portability significantly reduces diagnostic time
- Air Complete™ will help you to work faster, find more repair jobs, and make more money
- Compact, rugged and lightweight
- Ultra-fine flowmeter 4x more sensitive than before
- Compound pressure gauge
- Improved decay gauge eliminates “comebacks”



ONLY **£995.00**

## VDO AUTODIAGNOS CHECK WITH TPMS MODULE

The optimal diagnostic machine for service-level jobs.

- Airbag
- Climate Control
- Electronic Parking Brake
- EOBD
- Service Reset
- Steering Angle Sensors
- Tyre Pressure Monitoring
- DSG Gear Box
- Common Rail Diesel Injector Coding
- Battery Management



ONLY **£699.00**

# Delphi Diesel Diagnostics

NO HASSLE  
WARRANTY

BEST PRICE  
PROMISE

## SEALED RAIL KIT (YDT278)

The Delphi Diesel Sealed Rail Diagnostic Kit (YDT278) takes common rail diagnostics to another level by identifying the individual components of a common rail system that are failing. The kit provides simple, low-cost diagnostic capability for pumps and injectors on all makes of common rail systems.

Consisting of a sealed rail pressure tester and injector back leakage measurement equipment, the kit gives you on-vehicle capability to check the pressure being generated by a common rail pump and to identify individual injectors that fail.

Compatible with Delphi, Bosch, Siemens & Denso systems.



ONLY **£899.00**

## FALSE ACTUATOR KIT (YDT410)

Delphi has now taken common rail diagnostics even further with the launch of the False Actuator Kit (YDT410), giving you the capability to isolate actuator and mechanical faults on all makes of common rail pumps.

The kit contains eight false actuators, one for each of the major common rail systems on the market today.



ONLY **£335.00**

# Diesel Tools

NO HASSLE  
WARRANTY

BEST PRICE  
PROMISE

## DIESEL INJECTION LEAK BACK MASTER KIT. BOSCH, DELPHI AND DENSO

538 77 0261

Designed to measure return fuel flow on diesel vehicles up to 6 cylinders fitted with common rail injection system.

Identifies, worn, blocked or inoperative injectors quickly and easily.

Contains measurement tubes for short term tests and measurement bottles for long term, more accurate evaluation.

Master kit includes range of adaptors to suit Bosch, Delphi & Denso injectors for comprehensive coverage of common rail diesel vehicles.

Supplied in carry-case.



ONLY **£84.00**

## 14 PIECE INJECTOR EXTRACTOR WITH SLIDE HAMMER

538 77 1981

This professional tool is a specialised sliding hammer for removal of stuck and seized common rail injectors without dismantling the cylinder head for all injection nozzle cars.

The robust construction enables rapid withdrawal; even the most severely seized injector will come out with little fuss.

The kit comes with adaptors, 3.9kg weight, handle and injector extractors.



ONLY **£119.99**

Offers valid until 30 April 2015. Prices correct at time of going to press: January 2015. Prices exclude VAT, VAT will be applied at current rate. Errors & omissions excluded.

OVER 180 BRANCHES NATIONWIDE **0845 603 3636**



## THE DURAMETRIC PORSCHE DIAGNOSTIC TESTER

The Durametric is a hardware and software tool that reads and resets the different modules on Porsche vehicles. It plugs into your Windows PC's USB port (check system requirements), and once plugged into the car, the tool is capable of communicating with the different system control units in the car.

### Functions

- Reset service reminders
- Reads and clears Diagnostic Trouble Codes (DTC)
- Displays actual values
- Shows ECU information
- Turns off check engine light
- Turns off airbag light
- And much more

**ONLY £659.00** (Professional version)



## JAGUAR AND LAND ROVER ELECTRONIC PARK BRAKE RELEASE

- Moves the electronic park brake to the mount position
- Jaguar/Land Rover-approved device
- Saves time and money
- Easy to use with simple user interaction
- Stand-alone operation
- Easy to update for new vehicles and model years via a PC (PC application and cable included)



**ONLY £195.00**

## JAGUAR AND LAND ROVER SERVICE INTERVAL RESET

- Service re-set within 10 seconds
- Jaguar/Land Rover-approved device
- Saves time and money
- Removes the service interval warning from the instrument cluster
- Easy to use with simple user interaction
- Stand-alone operation
- Easy to update for new vehicles and model years



**ONLY £195.00**

## VAUXCOM

VAUX-COM PC-based diagnostic tool covers almost all Vauxhall/Opel cars and light vans and allows you to diagnose almost all modules including the engine management, airbag, ABS, immobiliser, instruments and many more.

- Fault code reading and clearing
- Live sensor data display
- Output tests let you switch components on and off for testing
- Programming and setting changes
- Key and key-fob programming



**ONLY £695.00**

## VCDS

UCDS is a Windows-based piece of software that turns your PC into a sophisticated diagnostic tool, capable of diagnosing VW, Audi, Seat and Skoda vehicles.

UCDS is a world-renowned software package that enables you to carry out all the functions of dealer testers and more expensive aftermarket tools.

- Covers latest CANBUS vehicles
- Virtually OEM-level software
- Coding – adaptation features
- Easy to use
- Low-cost solution
- Service reset



**ONLY £315.00**

Offers valid until 30 April 2015. Prices correct at time of going to press: January 2015. Prices exclude VAT, VAT will be applied at current rate. Errors & omissions excluded.

# Bosch Diagnostics

## KTS 540 WIRELESS BLUETOOTH® DIAGNOSTIC MODULE WITH 1-CHANNEL MULTIMETER

Fast troubleshooting with reliable results is a must for all vehicles entering workshops. With Bosch KTS technology you're well equipped to meet the requirements made by modern vehicle technology. The KTS 540 also includes an integrated ODB-exchange adapter which allows for future interface expansion as new diagnostic protocols are introduced.

No timeout diagnostic software offer.



**ONLY £1,795.00**  
WEEKLY FROM ONLY £9.88\*

## KTS 570 WIRELESS BLUETOOTH® DIAGNOSTIC MODULE WITH 2-CHANNEL OSCILLOSCOPE AND 2-CHANNEL MULTIMETER

The KTS 570 wireless module is fast and efficient. It features a 2-channel oscilloscope which can not only test all automotive sensors but can also internally monitor and recognise faults in the ECU's own diagnostic system. Within the control unit diagnosis, the signals of the diagnosis cables like the K and L line, CAN and SAE, can be analysed via the 2-channel diagnosis oscilloscope parallel to each step.



**ONLY £1,995.00** (Hardware only)  
WEEKLY FROM ONLY £10.98\*

### OFFER 1 KTS 570

With 1-year ESI(tronic) standard software subscription (C9) containing ECU diagnostics and guided troubleshooting.

**ONLY £2,195.00**  
WEEKLY FROM ONLY £12.09\*

### OFFER 2 KTS 570

With 1-year ESI(tronic) technical subscription (C9), mechanical information (M), in addition to wiring diagrams (P) and Technical Service Bulletins (TSB).  
Advanced software – 1 year.

**ONLY £2,495.00**  
WEEKLY FROM ONLY £13.74\*

### OFFER 3 KTS 570

With 3-year ESI[tronic] standard software subscription (C9) containing ECU diagnostics and guided troubleshooting.

**ONLY £3,395.00**  
WEEKLY FROM ONLY £18.69\*

### OFFER 4 KTS 570

With 3-year ESI[tronic] technical subscription (C9), mechanical information (M), in addition to wiring diagrams (P) and Technical Service Bulletins (TSB).  
Advanced software – 3 years.

**ONLY £3,995.00**  
WEEKLY FROM ONLY £22.60\*

\*Based on a five-year lease agreement. Subject to status. Full terms and conditions available on request. Other lease terms and finance options available on request. Offers valid until 30 April 2015. Prices correct at time of going to press: January 2015. Prices exclude VAT, VAT will be applied at current rate. Errors & omissions excluded.

OVER 180 BRANCHES NATIONWIDE 0845 603 3636

NO HASSLE  
WARRANTY

BEST PRICE  
PROMISE

## DCU 130 & KTS 570 PACKAGES

The DCU 130 is a heavy-duty tablet PC especially designed with the workshop needs in mind.

- Sturdy housing with 13.3" touch screen monitor
- Recessed USB port to enable protected connection of a dongle
- Bluetooth® and wireless LAN capabilities with an integrated camera
- Dust and splash proof to the IP54 standard
- Just one of the two supplied lithium-ion batteries is sufficient to operate the DCU 130 in the workshop and if required, the batteries can be replaced without interruption during regular operation (hot-swap function)



Integrated handle.



Recessed USB connection.



## FREE KTS USER TRAINING AT BOSCH STC (SERVICE TRAINING CENTRE) FOR ONE PERSON WITH ANY OF THESE PACKAGES



### OFFER 1 DCU 130 + KTS 570

With 1-year ESI(tronic) standard software subscription (C9) containing ECU diagnostics and guided troubleshooting.

ONLY **£5,495.00**  
WEEKLY FROM ONLY **£28.91\***

### OFFER 2 DCU 130 + KTS 570

With 1-year ESI(tronic) technical subscription (C9), mechanical information (M), in addition to wiring diagrams (P) and Technical Service Bulletins (TSB). Advanced software – 1 year.

ONLY **£5,795.00**  
WEEKLY FROM ONLY **£30.49\***

### OFFER 3 DCU 130 + KTS 570

With 3-year ESI(tronic) standard software subscription (C9) containing ECU diagnostics and guided troubleshooting.

ONLY **£6,595.00**  
WEEKLY FROM ONLY **£34.70\***

### OFFER 4 DCU 130 + KTS 570

With 3-year ESI(tronic) technical subscription (C9), mechanical information (M), in addition to wiring diagrams (P) and Technical Service Bulletins (TSB). Advanced software – 3 years.

ONLY **£6,995.00**  
WEEKLY FROM ONLY **£36.80\***

\*Based on a five-year lease agreement. Subject to status. Full terms and conditions available on request. Other lease terms and finance options available on request. Offers valid until 30 April 2015. Prices correct at time of going to press: January 2015. Prices exclude VAT, VAT will be applied at current rate. Errors & omissions excluded.

KNOWLEDGE AND EXPERTISE ACROSS THE UK **0845 603 3636**

# Launch Diagnostics

NO HASSLE  
WARRANTY

BEST PRICE  
PROMISE

## LAUNCH X431 PRO

Tablet-style car diagnostics device based on and specifically designed for Android operating systems, allowing users to download any Android software and work with a familiar user interface. With Bluetooth communications to the DBScar connector and a mobile terminal.

Covers a wide range of car models including European, Asian, American and Chinese models. It also has a range of powerful test functions and provides extremely accurate test data.

ONLY **£1,195.00** With 1 year of software updates  
WEEKLY FROM ONLY **£10.98<sup>+</sup>**



## LAUNCH X431 PRO 3

A most reliable and all-encompassing diagnostic tool with wireless and Bluetooth connectivity. A built-in social network service enables users to connect to a community for help with diagnosis. Remote diagnosis also possible, with 'golo' option.

Users have access to a car database and repair tips.

- Full system diagnosis
- Data stream storage and re-display
- Service Light re-sets
- Coding, re-set, and programming functions
- Diesel Particulate filters regeneration/replacement
- Online tech support and advice
- Electronic Parking Brake Reset
- Key/immobiliser coding
- VIN recognition, autosearch
- Live data recording and multiple graphing
- Manufacturer-specific Special Functions

ONLY **£1,695.00** With 1 year of software updates  
WEEKLY FROM ONLY **£9.33<sup>+</sup>**



## LAUNCH X431 EURO PAD

The all-new Launch X431 Euro Pad featuring DBS (Diagnosis Based Solutions) technology.

The X431 Euro Pad is a tablet computer featuring the next generation of Launch software and vehicle connectivity. DBS diagnosis-based solutions is the culmination of 20 years of diagnostic expertise. At the heart of DBS is a unique Launch-designed microchip located in the diagnostic connector.

- Greatly expanded vehicle coverage, now over 75 programmes
- 12-month software updates included
- Complete with all connectors and cables
- Built-in thermal printer
- The latest Bluetooth® technology with LPT (Large Packet Transfer)
- 9.7-inch LCD touch screen with IPS offering unparalleled off-axis viewing and clarity
- 2.0 megapixel camera for single shots or video

Offering a true wireless PC-based experience with an embedded Windows 7 operating system, multiple applications can be run simultaneously at blazing speeds. Perform diagnostics, view and record live data streams while on the internet gathering repair information.

- Powerful and fast vehicle diagnostics driven by Launch software
- Ethernet or wireless connection for automatic software updates
- Web browser for internet connection
- VGA and HDMI ports for connection to external displays
- Module coding, resets, relearns and bi-directional capabilities
- View up to 12 items of live data simultaneously



**OFFER 1**  
LAUNCH X431 EURO PAD +  
1 YEAR OF SOFTWARE UPDATES  
ONLY **£2,950.00**  
WEEKLY FROM ONLY **£15.41<sup>+</sup>**

**OFFER 2**  
LAUNCH X431 EURO PAD +  
3 YEARS OF SOFTWARE UPDATES  
ONLY **£3,495.00**  
WEEKLY FROM ONLY **£19.24<sup>+</sup>**

\*Based on a five-year lease agreement. Subject to status. Full terms and conditions available on request. Other lease terms and finance options available on request. Offers valid until 30 April 2015. Prices correct at time of going to press: January 2015. Prices exclude VAT, VAT will be applied at current rate. Errors & omissions excluded.

OVER 180 BRANCHES NATIONWIDE 0845 603 3636

# Brain Bee X-Touch

NO HASSLE  
WARRANTY

BEST PRICE  
PROMISE

## NEW PRODUCT BRAIN BEE X-TOUCH



Brain Bee's new X-Touch is a Wireless Diagnostic System combining an EOBD dongle with a high-specification tablet PC in bluetooth communication. Running the comprehensive, fast and easy-to-use Brain Bee diagnostic software, this new configuration brings an added dimension of flexibility to diagnostic testing, free from the limitations of cable communication.

The Brain Bee software is a multi-make, multi-level database and operating platform that delivers a complete diagnostic solution. The software is under constant development to continually improve the intelligence of the testing capability. New additional functions, multiple interfaces and queries, more intuitive graphics and higher speed are the main features making the Brain Bee X-Touch system the best prospect among the new generation wireless scan tools.

- Fault code scanning
- Live data display and colour graphing
- Component activations
- System adjustments
- Coding and programming
- Special functions
- Intelligence and dynamic testing
- Service light reset
- Brake rewind
- Particulate filter regeneration
- ECU information reading
- Parameter/status reading
- Fault codes reading
- Visual identification of the position of Diagnostic sockets and adaptor ( if required )
- Pass-thru capable

**12-MONTH SOFTWARE UPDATE PACKAGE INCLUDED**  
**24 & 36-MONTH SOFTWARE UPDATE OPTIONS AVAILABLE**

ONLY **£1,195.00**  
WEEKLY FROM ONLY **£6.58<sup>+</sup>**

\*Based on a five-year lease agreement. Subject to status. Full terms and conditions available on request. Other lease terms and finance options available on request. Offers valid until 30 April 2015. Prices correct at time of going to press: January 2015. Prices exclude VAT, VAT will be applied at current rate. Errors & omissions excluded.

KNOWLEDGE AND EXPERTISE ACROSS THE UK **0845 603 3636**

## FSA 500 VEHICLE SYSTEM ANALYSER

- The handy FSA 500 from Bosch is the perfect entry into cost-effective vehicle system analysis.
- Compact, battery-powered measurement module with Bluetooth® connection to a PC system (DCU 130 tablet PC, laptop or PC with Windows operating system)
- Software for testing the most important electrical and electronic components in the vehicle
- Time-saving testing of components when still installed
- Around 30 preset component tests
- Signal generator for simulation of sensor signals
- Battery peak-coil current measurement up to 24 hours
- Convenient universal oscilloscope with 2-channel (2 x 40 MS/s) and 4-channel modes (4 x 1 MS/s)
- Test of vehicle bus systems (e.g. CAN bus)
- Importing and saving comparative curves

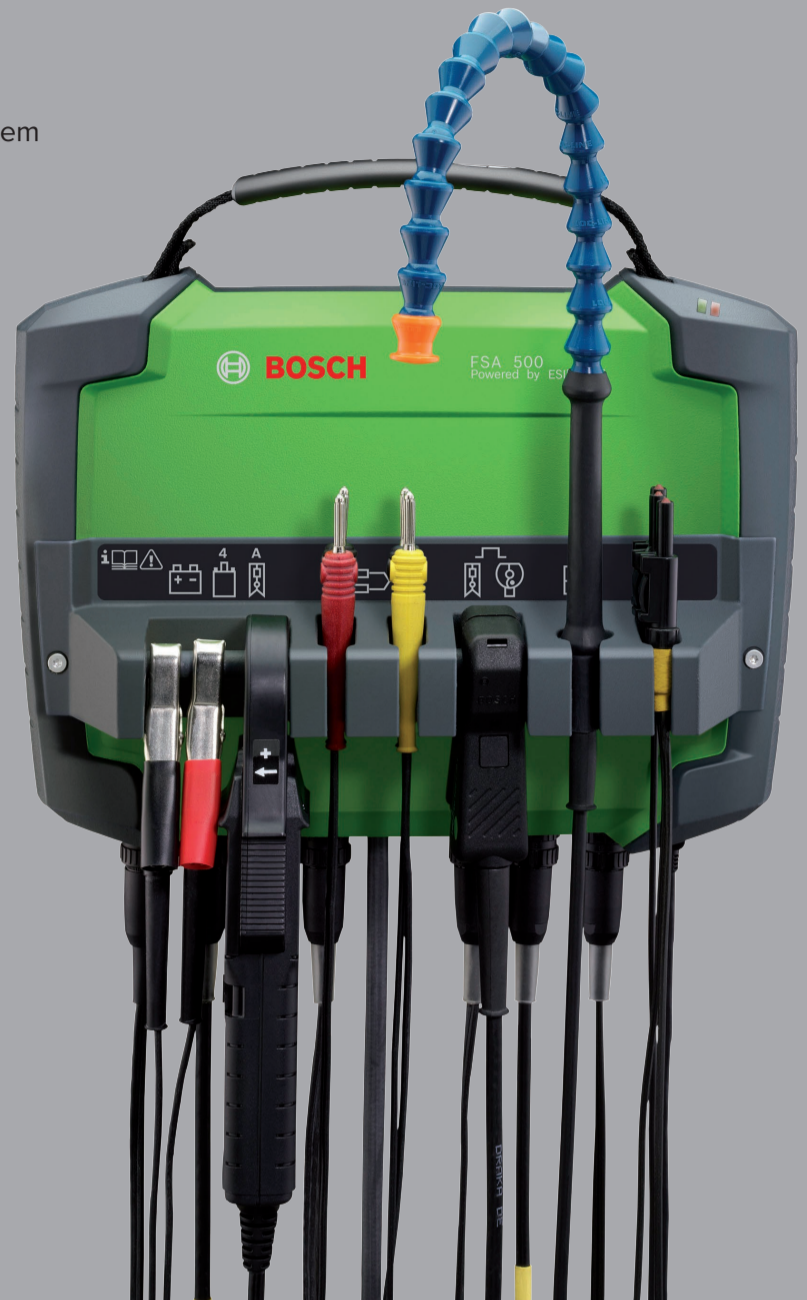

ONLY **£2,495.00**  
WEEKLY FROM ONLY **£13.74<sup>†</sup>**

## THE NEW 4-CHANNEL ADVANCED KIT FROM PICO

Move up to the next level with the Pico oscilloscope and eliminate guess work. A one-off payment includes software upgrades and technical support for life. More than an oscilloscope; the kit can be used to test and measure virtually all of the electrical and electronic components and circuits in modern petrol and diesel vehicles including:

- Ignition – primary and secondary
- Injectors and fuel pumps
- Battery, starter and charging circuits
- ABS sensors, crank and cam sensors
- Lambda (oxygen), airflow, knock and MAP sensors
- Glow plugs / timer relays
- Relative compression tests
- FlexRay, CAN and LIN bus



ONLY **£1,995.00**  
WEEKLY FROM ONLY **£10.98<sup>†</sup>**

<sup>†</sup>Based on a five-year lease agreement. Subject to status. Full terms and conditions available on request. Other lease terms and finance options available on request. Offers valid until 30 April 2015. Prices correct at time of going to press: January 2015. Prices exclude VAT, VAT will be applied at current rate. Errors & omissions excluded.

OVER 180 BRANCHES NATIONWIDE **0845 603 3636**

## G-SCAN LITE

The number one diagnostic tool for asian vehicles.

G-Scan was first launched in Japan in 2008 after Japanese company INS and Korean Corporation GIT joined forces; this collaboration brought together the market leaders in OEM-quality data for Japanese and Korean vehicles, which includes the most comprehensive coverage of Japanese 'Grey' imports.

- Best-selling diagnostic tool in Japan 2008-2012
- Unique to G-Scan – current OEM software for Hyundai & Kia
- Rapidly-expanding European vehicle coverage
- 2-year warranty\*

### FEATURES AND FUNCTIONS:

- Super-fast dual processor means high-speed performance
- HD 5.6" colour touch screen 12-button menu
- Flight record mode, record live data for later analysis
- CAN-enabled, no external module or adaptor
- Software updates and customer support
- Communicates with 24V commercial vehicles
- Comprehensive coverage on 'Grey' import models
- Shows full DTC descriptions

- Memo and screen grab functions
- No software timeout
- Rechargeable lithium polymer battery
- High-speed data transferring to a PC via Wi-Fi for real-time PC interface – Wi-Fi kit sold separately
- Vehicle system auto search
- DTC (Diagnostic Trouble Code) read and clear
- BCM (Body Control Module) actuation tests
- Component and ECU programming/coding
- Key coding/programming
- DPF (Diesel Particulate Filter) regeneration
- Live data streaming and graphing, displaying 4 graphs at a time
- Service/warning light reset
- EPS (Electronic Power Steering) recalibrations
- Diesel injector copying/writing
- ABS (Antilock Braking System) analysis

- SRS (Supplementary Restraint Systems)
- Airbag analysis
- ECU information display
- AT/CVT Learning Value Initialisation
- EGR (Exhaust Gas Regulator) self-test mode

\*The Li-ion battery and carry case are covered by a 1-year warranty.



**ONLY £1,495.00**

**WEEKLY FROM ONLY £8.23<sup>†</sup>**

## G-SCAN 2

G Scan 2 with built in 4 Channel Oscilloscope & Digital Multimeter

All the outstanding capability and performance of the G-Scan Lite, plus...

- Built in Oscilloscope
- Digital Multimeter
- Super fast triple processor for high speed performance
- Communication line inspection function
- Simulation function for in-depth diagnostics
- Built in Wi-Fi for cable free updates, PC connectivity and printing
- 7" High definition, sunlight readable, LCD colour touch screen
- 12 button menu navigation system
- 16GB SD memory card
- Windows CE 6.0 operating system
- Special functions calculator for Ohm's law, parallel resistances and more
- Handy unit converter
- Market leading coverage for Asian cars and trucks
- Instant boot-up from standby mode

### PLUS...

- Two year warranty and Two year free software updates

**ONLY £2,495.00**

**WEEKLY FROM ONLY £13.74<sup>†</sup>**



## G-SCAN ASIAN

G Scan with all the adapters to cover Asian vehicles with a pre EOBD socket. The package of necessity for the Asian specialist...

**ONLY £2,695.00**

**WEEKLY FROM ONLY £14.84<sup>†</sup>**

<sup>†</sup>Based on a five-year lease agreement. Subject to status. Full terms and conditions available on request. Other lease terms and finance options available on request. Offers valid until 30 April 2015. Prices correct at time of going to press: January 2015. Prices exclude VAT, VAT will be applied at current rate. Errors & omissions excluded.



# Look out for our Tools2Trade Van located in your area NOW!

We understand that sometimes you are just too busy leave the garage to get the equipment you need. That's why we have decided to bring our stock to you.

Our Tools2Trade van carry the tools that you require to carry out your daily tasks efficiently. We come to you and give you the opportunity to have a look the tools we have available and give you the opportunity to make a purchase.

Our van stocks a wide range of tools from everyday hand tools to diagnostics, trolley jacks, and air conditioning. Covering various brands including, Klann, MasterPro, Pagid Professional Tools, SIP and Sykes Pickavant.

**Call your local branch and have our Tools2Trade drive to you.**

OVER 180 BRANCHES NATIONWIDE **0845 603 3636**